



02.02.2022

## D-Max Wall

### Advantages compared to exterior insulation

- Can be sprayed regardless of temperature or wind (up to -20°C)
- No scaffolding or vessel necessary. Less machinery therefore less rental cost, logistics and risk of accident.
- Building insulation can be performed as the walls go up.
- Less materials therefore time and costs savings for execution.
- Important heating cost savings in winter.
- Avoids exterior compartmentalization (NBC Article 3.1.11.2.).
- CAN/ULC S101 tested assembly for high rise buildings (>3 storeys) (UL EW25).
- Sequencing of work simpler and easier to manage for the superintendent since there are less workers to execute each step.
- Avoids overspray.
- Avoids having to install an interior furring in comparison with a wool insulated cavity where the electricity cannot run through the stud cavity.

### Assembly:

- Lightweight or brick siding
- Omega bars or brick ties
- Exterior sheathing with taped joints (Densglass Gold, Securock, Glasroc)
- Heatlok Soya HFO R-6/inch (variable thickness)
- Z girts (variable thickness)
- Steel stud 6" or 3 5/8"
- Interior gyprock

## PARTIAL LIST OF D-MAX PROJECTS

Name of Project
<b>Completed</b>
Le Saint-Philippe
Bâtiment K
Le Nicolas
Saphir
Liénard
Le Guillaume
Archipel
Huma 2
<b>To Come</b>
Circa Condo
800 Charest
Lokia
Réseau Sélection Mirabel
Viridi
Novit
Père Le Lièvre
Sir John
Maison de femmes autochtones
Satori
Lab École-Gatineau
Ilot St-Charles
District Concorde (3 tours)
Mgr Plessis
Capella
Newman RPA Ph2
Maestria tour 1 (alcove)
Maestria tour 2 (alcove)
Maison Benoit Labre
Concordia
Symposium
Medway (800 route des rivières)
Place Frontenac
<b>Alternative D-Max Projects</b>
Château Bellevue 2
Les Loges 6
Le Fleurimont
Huma 1

870 Curé Boivin, Boisbriand, Quebec, Canada J7G 2A7  
 Tel: 450.437.0123 866.437.0223  
[www.huntsmanbuildingsolutions.com](http://www.huntsmanbuildingsolutions.com)

A business unit of Huntsman Corporation



Nicolas Project



K Building Project



Saint-Philippe Project











# D-MAX WALL

BEFORE THE START OF CONSTRUCTION OF THE WALL ASSEMBLY, A START-UP MEETING IS STRONGLY RECOMMENDED WITH THE DIFFERENT PROFESSIONALS TO COORDINATE CONSTRUCTION STEPS AND DETAILS. WE ARE AVAILABLE FOR THIS MEETING.

1) THE ADVANTAGE OF THIS WALL SECTION IS A MAXIMUM EFFECTIVE R VALUE IN A VERY THIN WALL. THIS INCREASES THE INHABITABLE FLOOR SPACE. THE STUD CAN BE A 92 MM OR A 152 MM DEPENDING ON THE DESIGNER'S CHOICE.

2) THIS WALL SECTION ALLOWS TO APPLY ALL THE INSULATION FROM THE INTERIOR, SHELTERED FROM THE WEATHER AND WITHOUT SCAFFOLDING.

3) THE OUTER Z BAR'S THICKNESS IS VARIABLE FROM 25 TO 125 MM ACCORDING TO THE DESIRED EFFECTIVE R VALUE AND DESIGN CHOICES.

4) A MINIMUM THICKNESS OF 38MM IS RECOMMENDED TO COVER THE OUTER Z BAR FROM INSIDE TO CUT THE THERMAL BRIDGE.

5) WHEN THE INTERIOR AIR SPACE IS MORE THAN 25 MM, ARTICLE 3.1.11.2 APPLIES.

6) HUNTSMAN BUILDING SOLUTIONS IS AVAILABLE FOR REVIEWING PROJECT DETAILS, FOR A COORDINATION MEETING AT THE BEGINNING OF THE PROJECT AND FOR SITE INSPECTIONS DURING THE WORKS.

## NOTES

**A** THE FLEXIBLE FLASHING ABOVE OPENINGS MUST EXCEED 200mm (8") MIN. ON BOTH SIDES OF THE OPENING

**B** RAISE THE SELF-ADHESIVE MEMBRANE 75mm (3") ON THE JAMB

**C** MEMBRANES MUST BE INSTALLED ACCORDING TO MANUFACTURERS' REQUIREMENTS

NOTES: A FULL SURFACE MEMBRANE CAN BE USED DEPENDING ON THE DESIGNER'S CHOICE (NON ILLUSTRATED)

Date: 03-05-2022

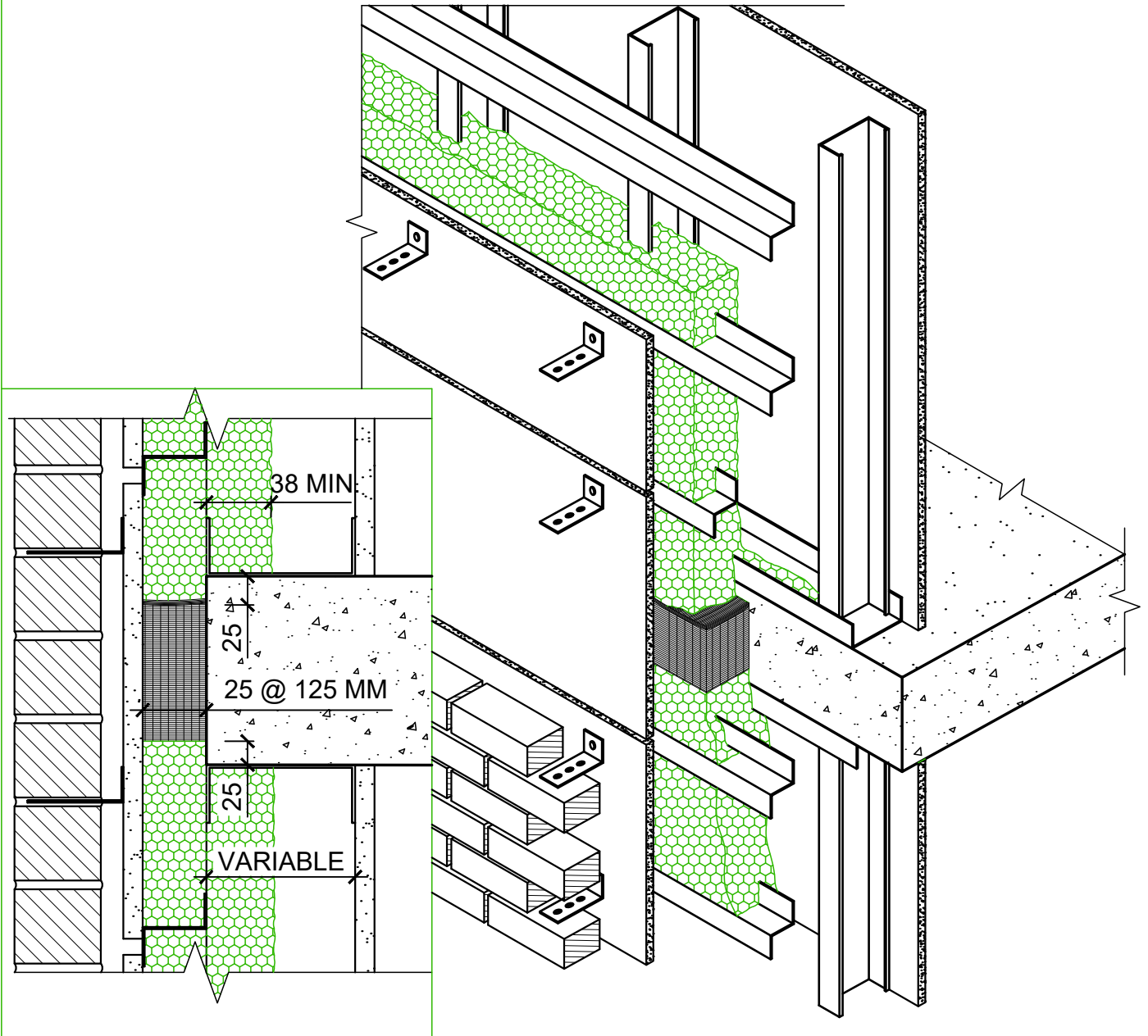

ISOMETRY  
BRICK SIDING

Date:03-05-2022

Scale: Variable



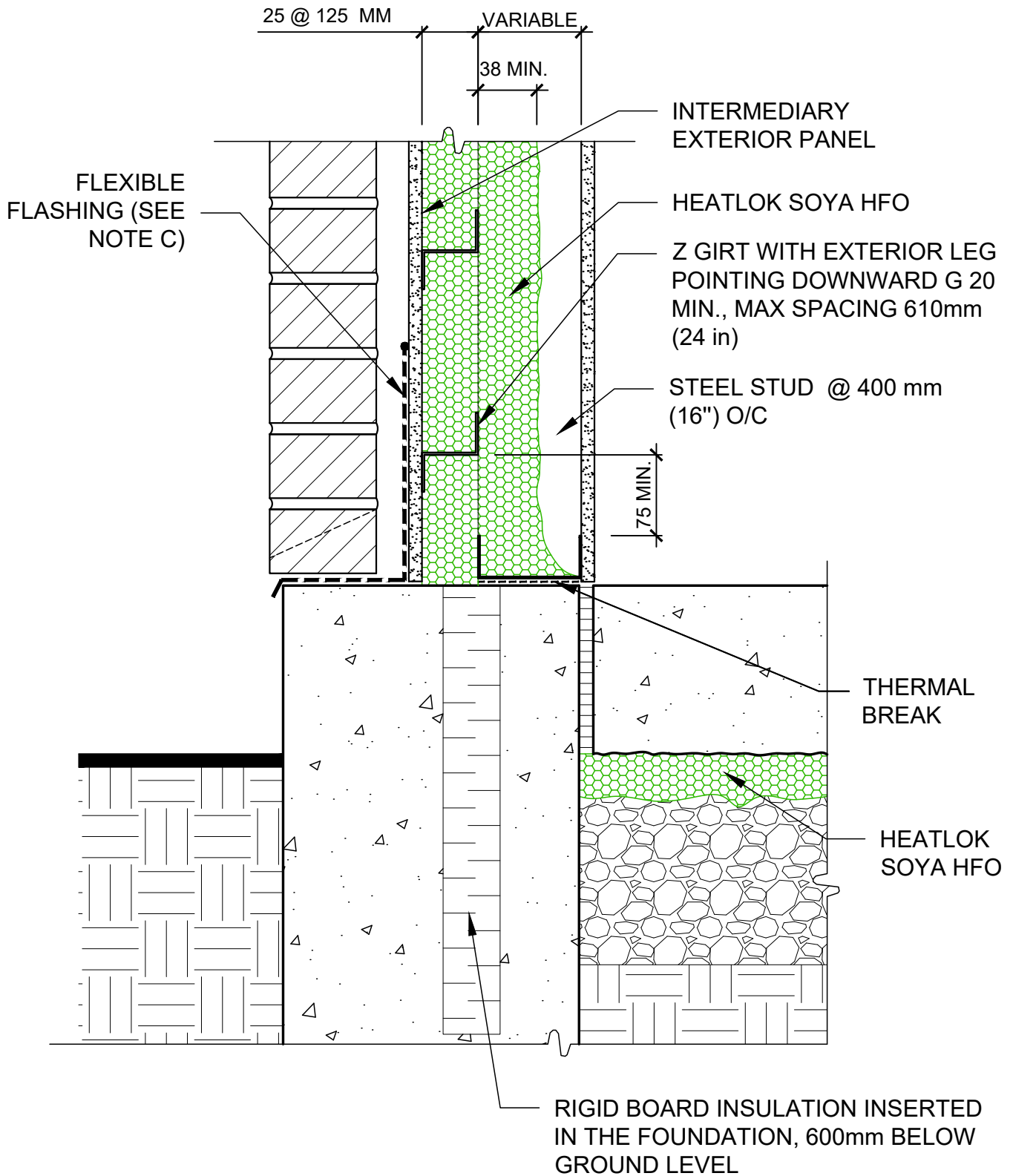

THROUGH WALL MEMBRANE AT FOUNDATION  
WALL JUNCTION - BRICK SIDING

Date: 03-05-2022

SCALE : 1:5

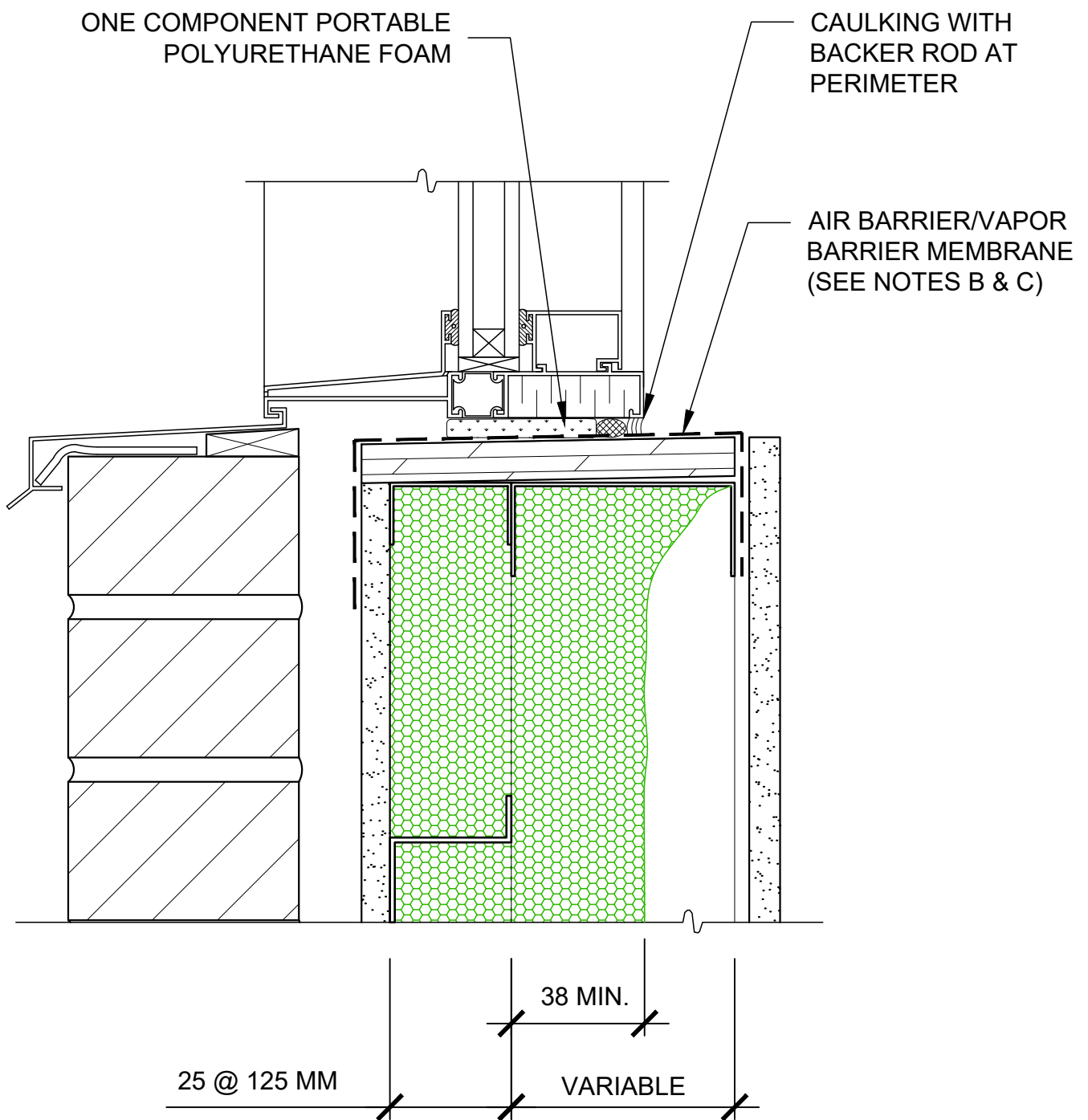

WINDOW SILL  
BRICK SIDING

Date: 03-05-2022

SCALE: 1:2.5

ONE COMPONENT PORTABLE  
POLYURETHANE FOAM

CAULKING WITH  
BACKER ROD AT  
PERIMETER

AIR BARRIER/VAPOR  
BARRIER MEMBRANE  
(SEE NOTES B & C)

INJECTION  
DRILLING @  
400MM C/C (16")  
IF REQUIRED

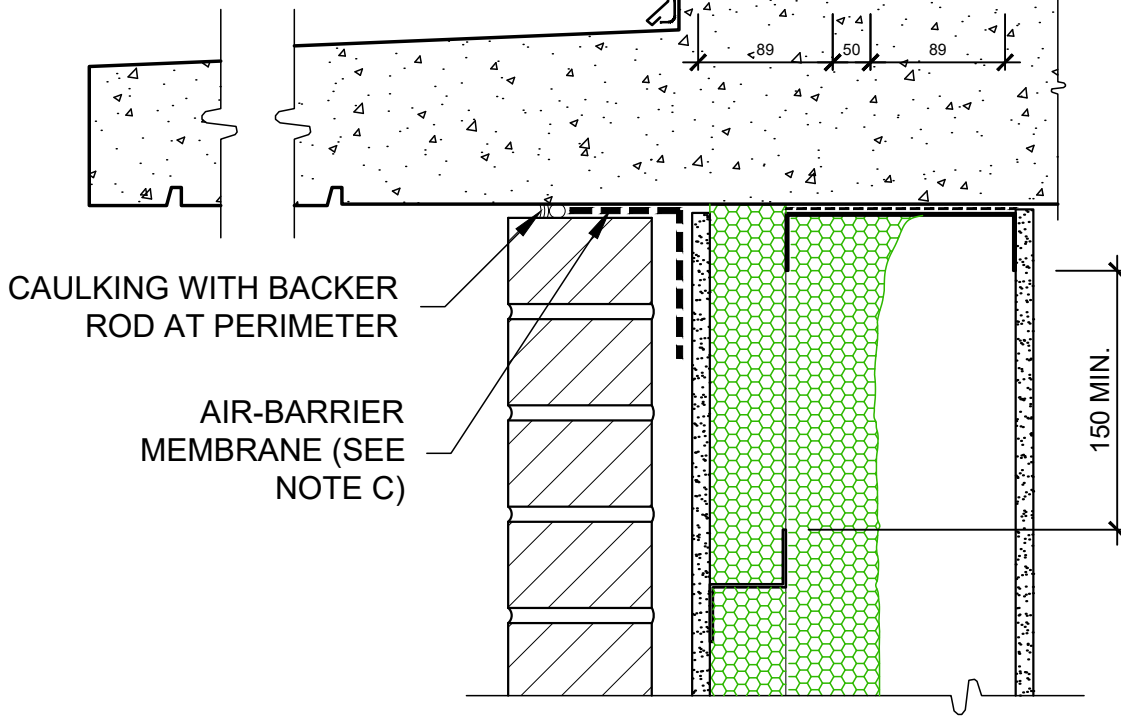

BALCONY/FLOOR SLAB JUNCTION  
BRICK SIDING

Date: 03-05-2022

Scale: 1:5



NOTE: FOR SUPPORT PURPOSES AT OPENINGS, THE WINDOW SUPPORT POSTS MAY BE DOUBLED AND INJECTED WITH HEATLOK SOYA HFO.

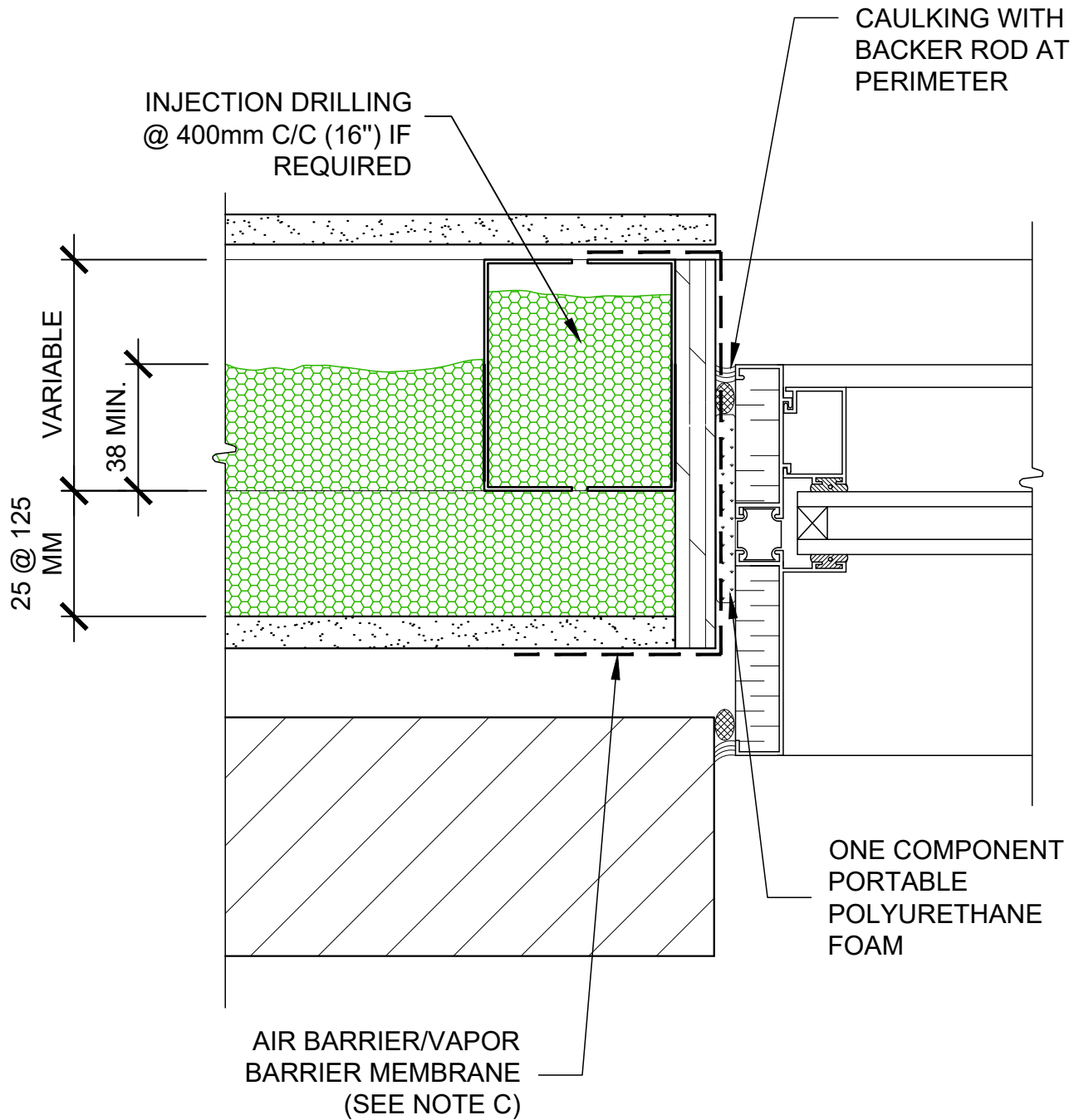

WINDOW JAMB  
BRICK SIDING

Date: 03-05-2022

SCALE: 1:2.5

FLEXIBLE FLASHING  
(SEE NOTES A & C)

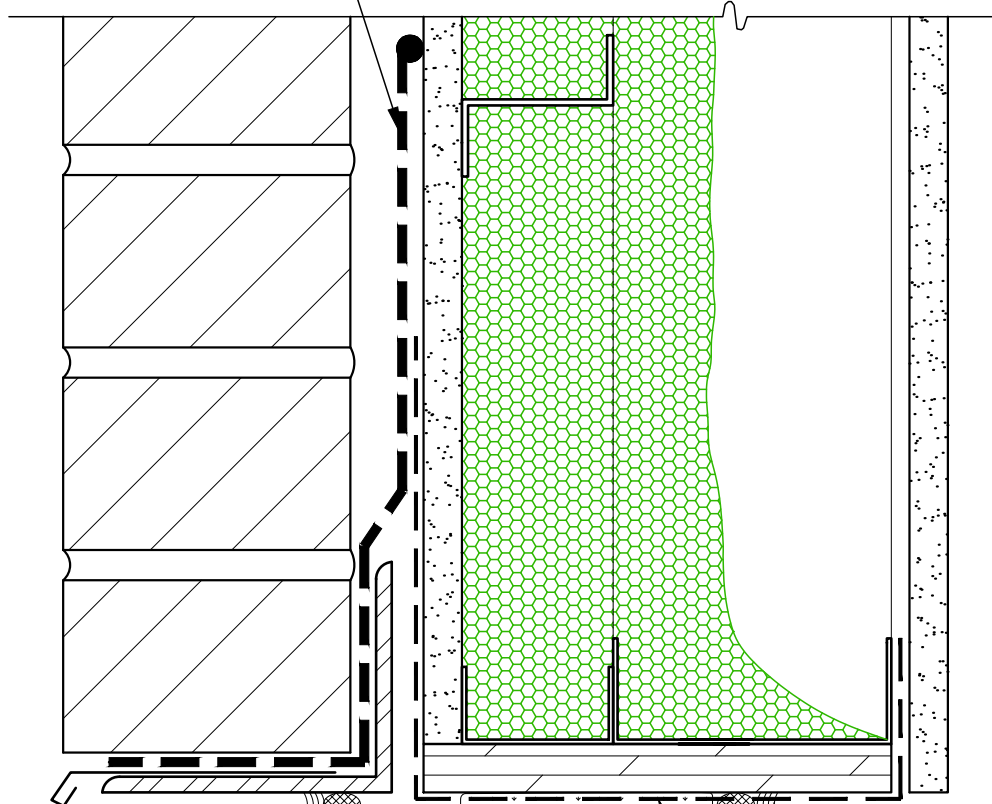
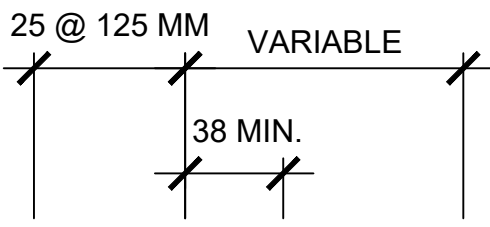

CAULKING WITH  
BACKER ROD AT  
PERIMETER

ONE COMPONENT PORTABLE  
POLYURETHANE FOAM

AIR BARRIER/VAPOR  
BARRIER MEMBRANE  
(SEE NOTE C)

TOP OF WINDOW  
BRICK SIDING

Date: 03-05-2022

SCALE: 1:2.5

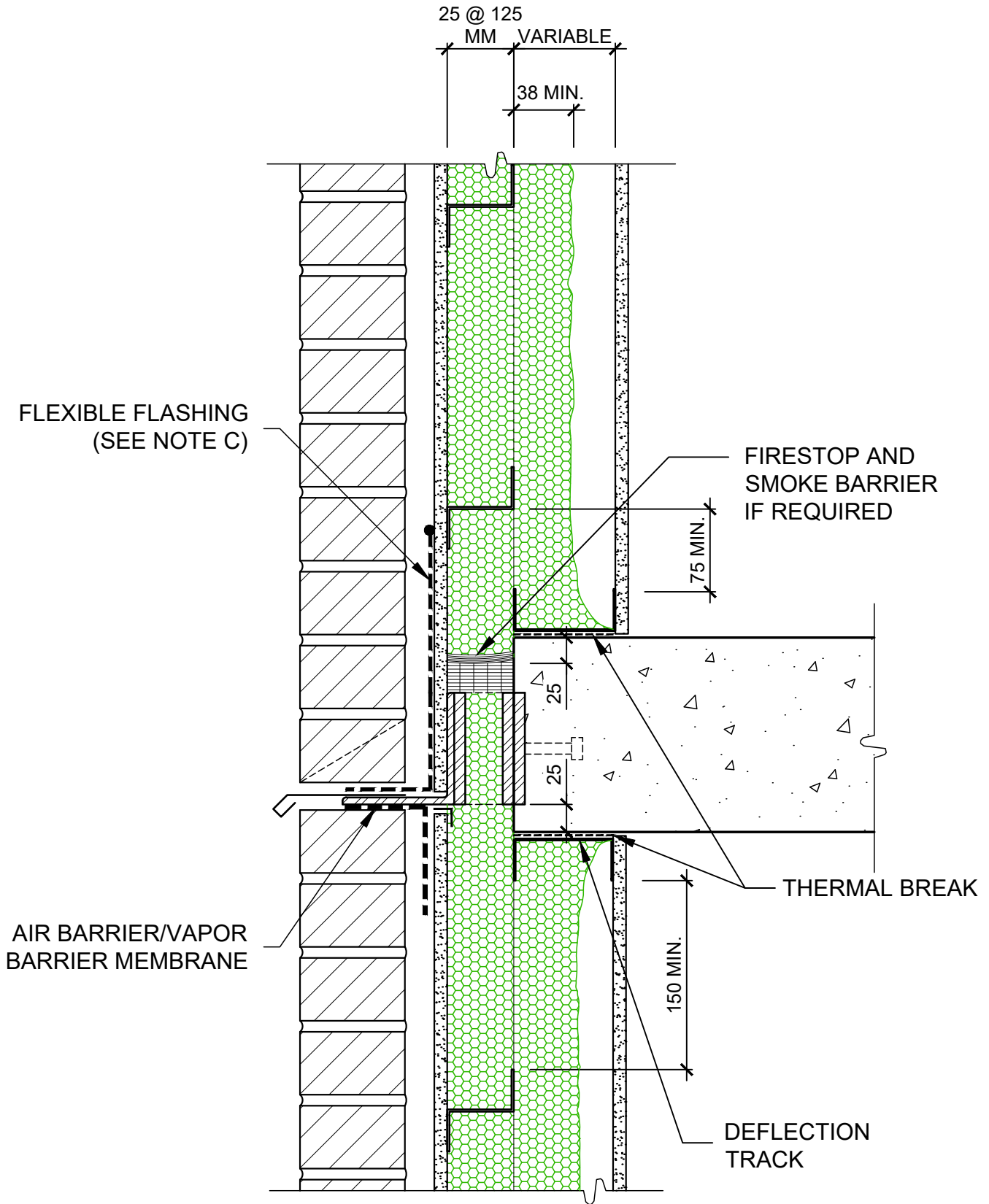

FLOOR JUNCTION  
BRICK SIDING

Date: 03-05-2022

SCALE : 1:5



AIR BARRIER/VAPOR  
BARRIER MEMBRANE  
(SEE NOTE C)

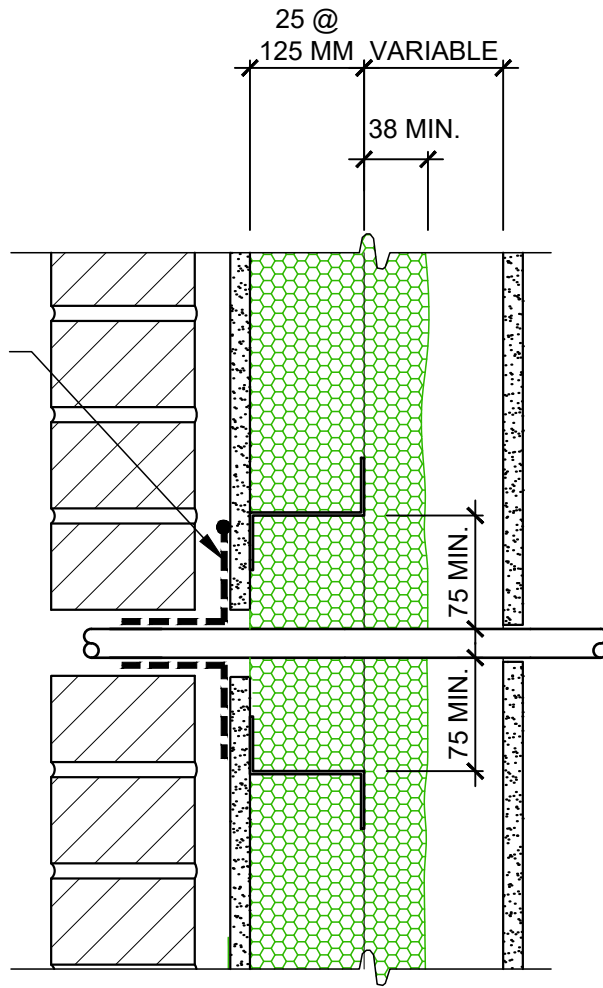

DETAIL AT WALL PENETRATION  
BRICK SIDING

Date: 03-05-2022

SCALE : 1:5

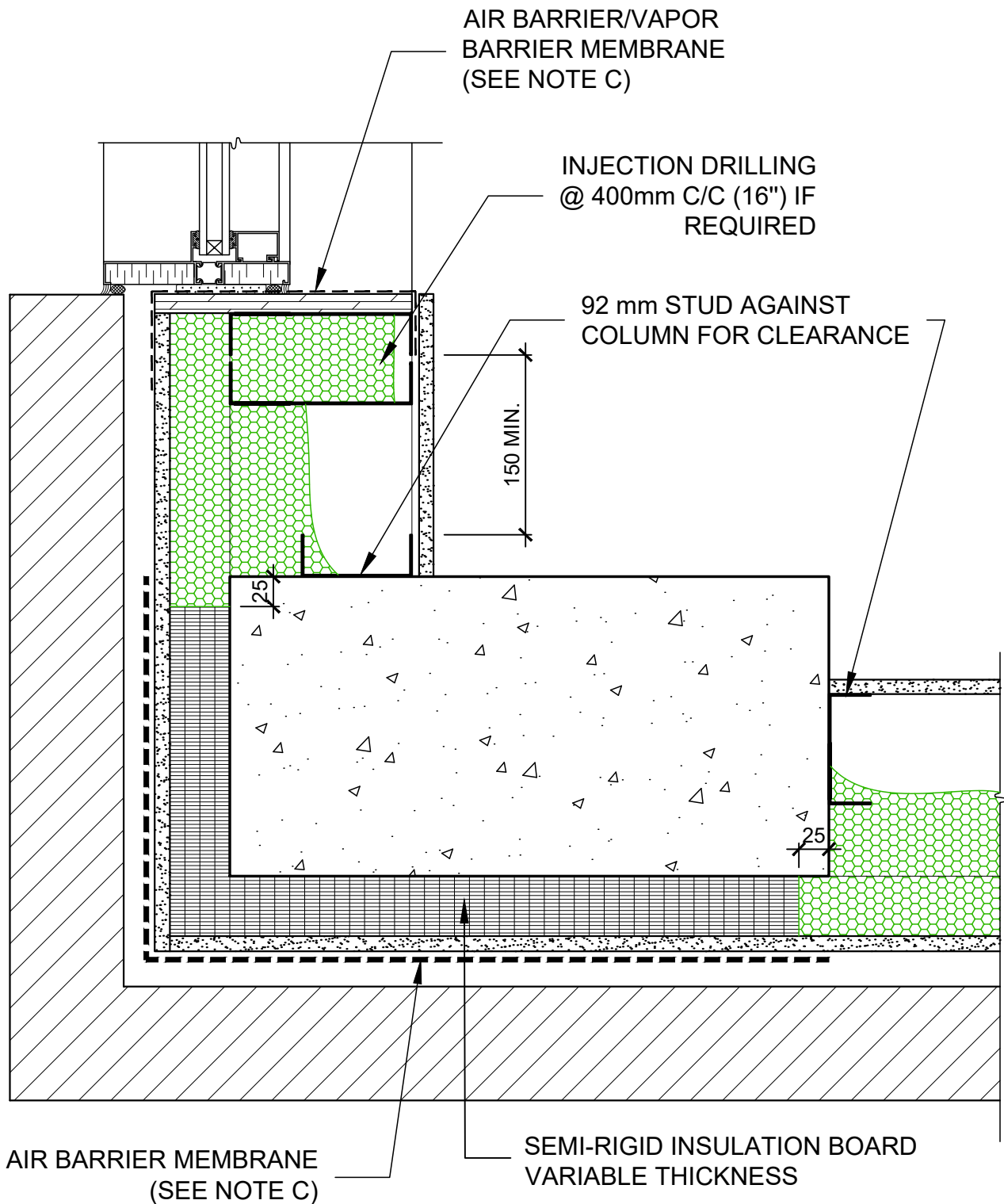

COLUMN AND WALL JUNCTION - BUILDING CORNER  
BRICK SIDING

Date: 03-05-2022

SCALE : 1:5

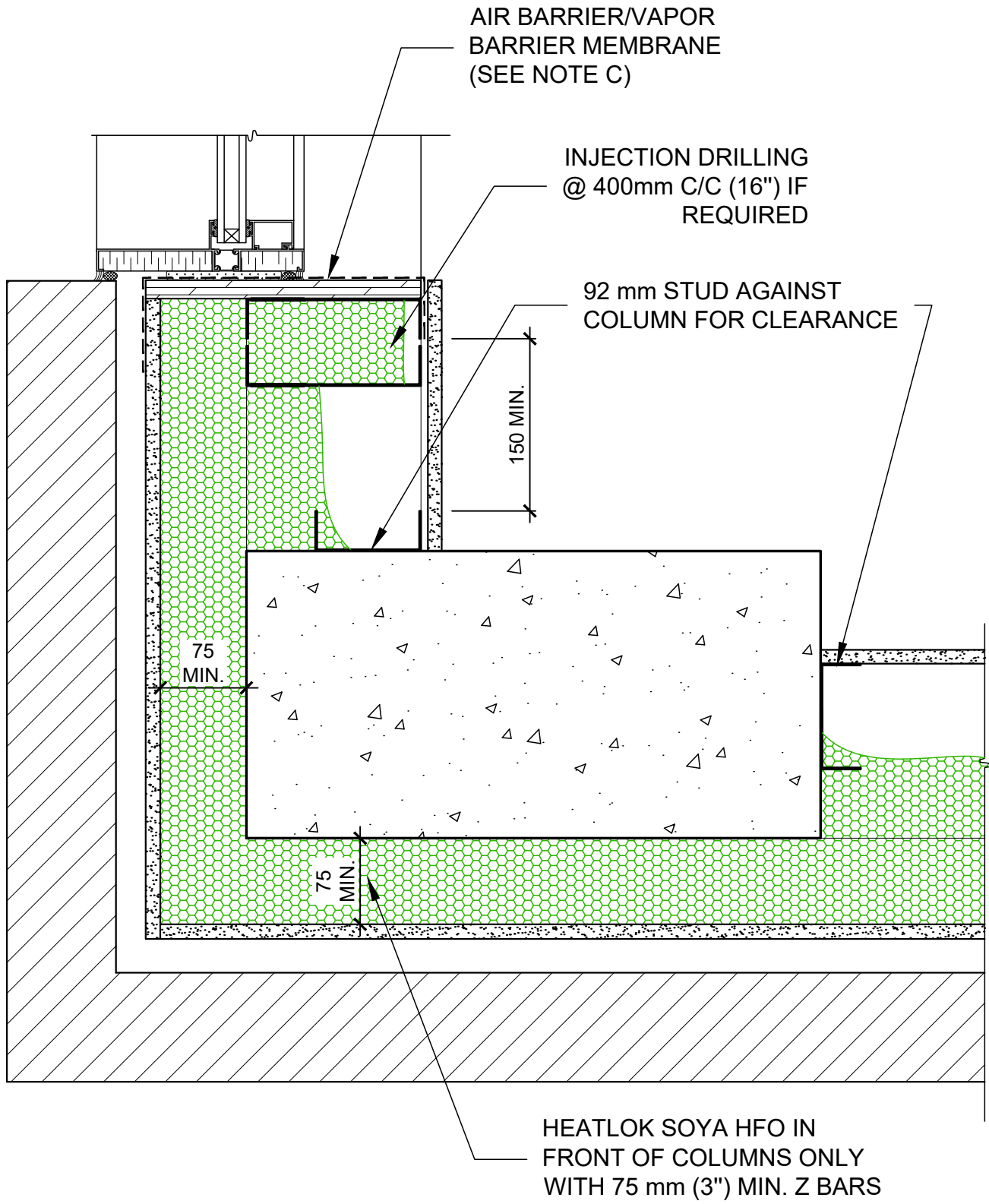

COLUMN AND WALL JUNCTION - BUILDING CORNER  
BRICK SIDING

Date: 03-05-2022

SCALE : 1:5



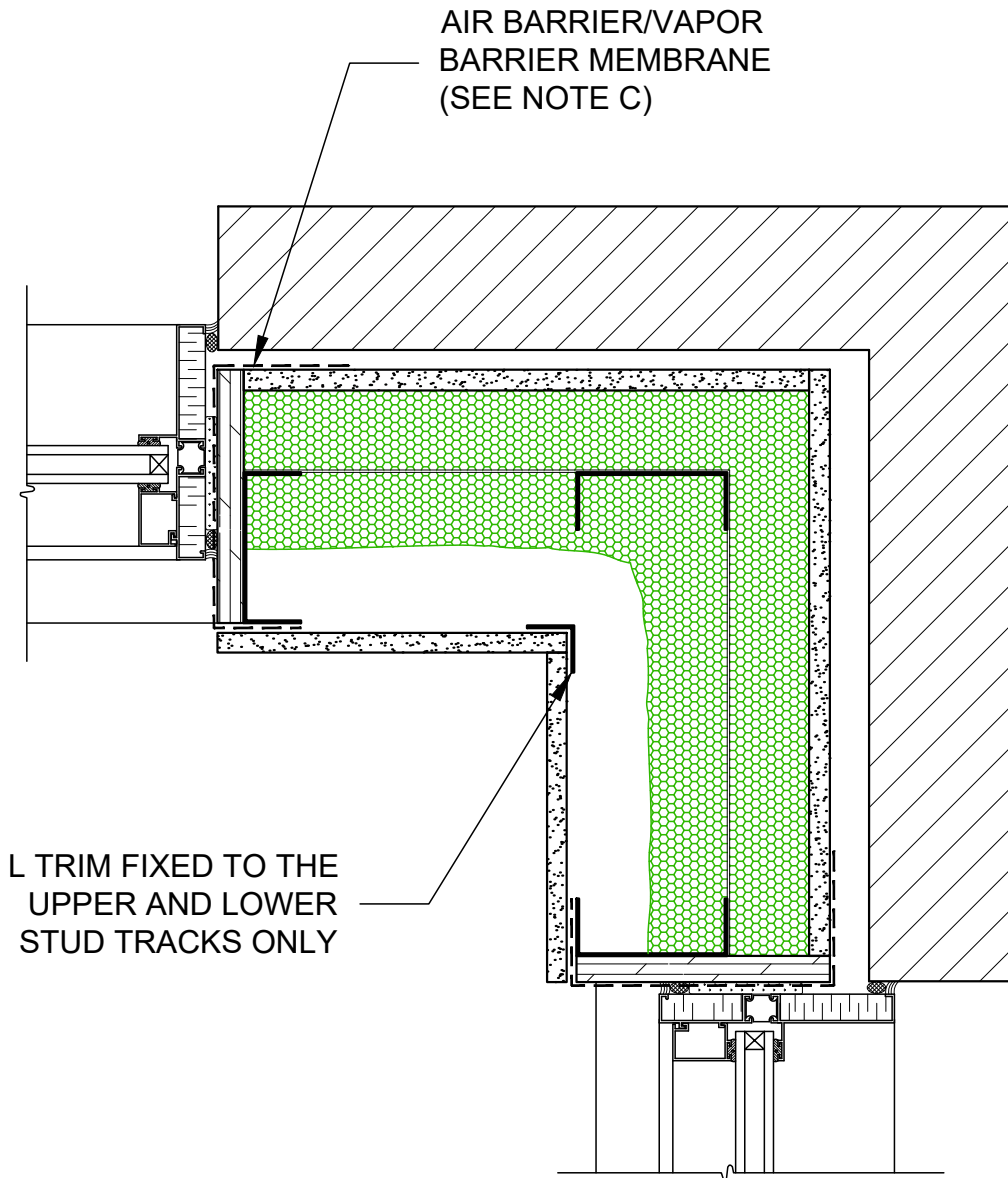

BUILDING CORNER STUD PLACEMENT  
BRICK SIDING

Date: 03-05-2022

SCALE : 1:5

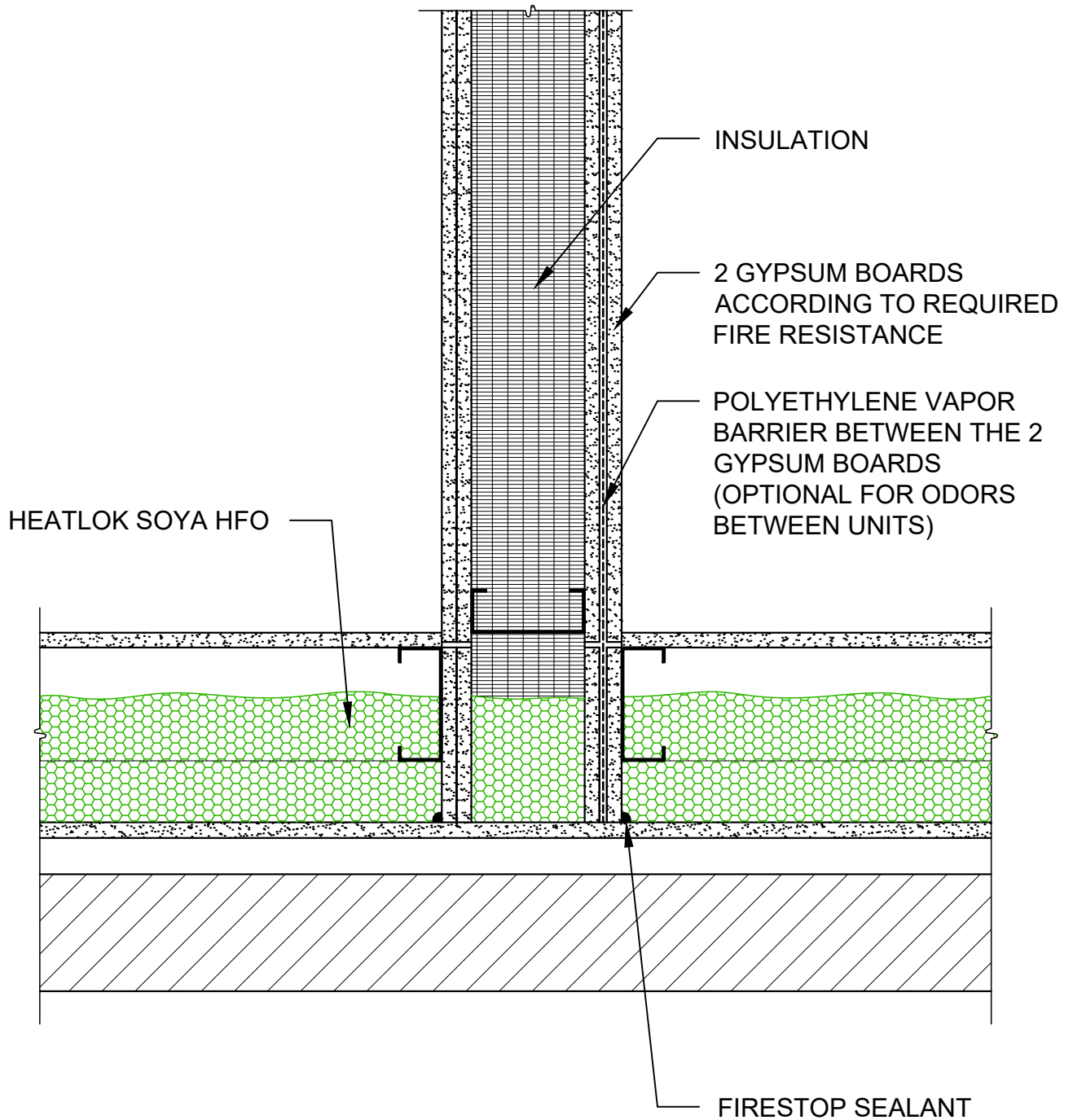

FIRE SEPARATION  
BRICK SIDING

Date: 03-05-2022

SCALE : 1:5

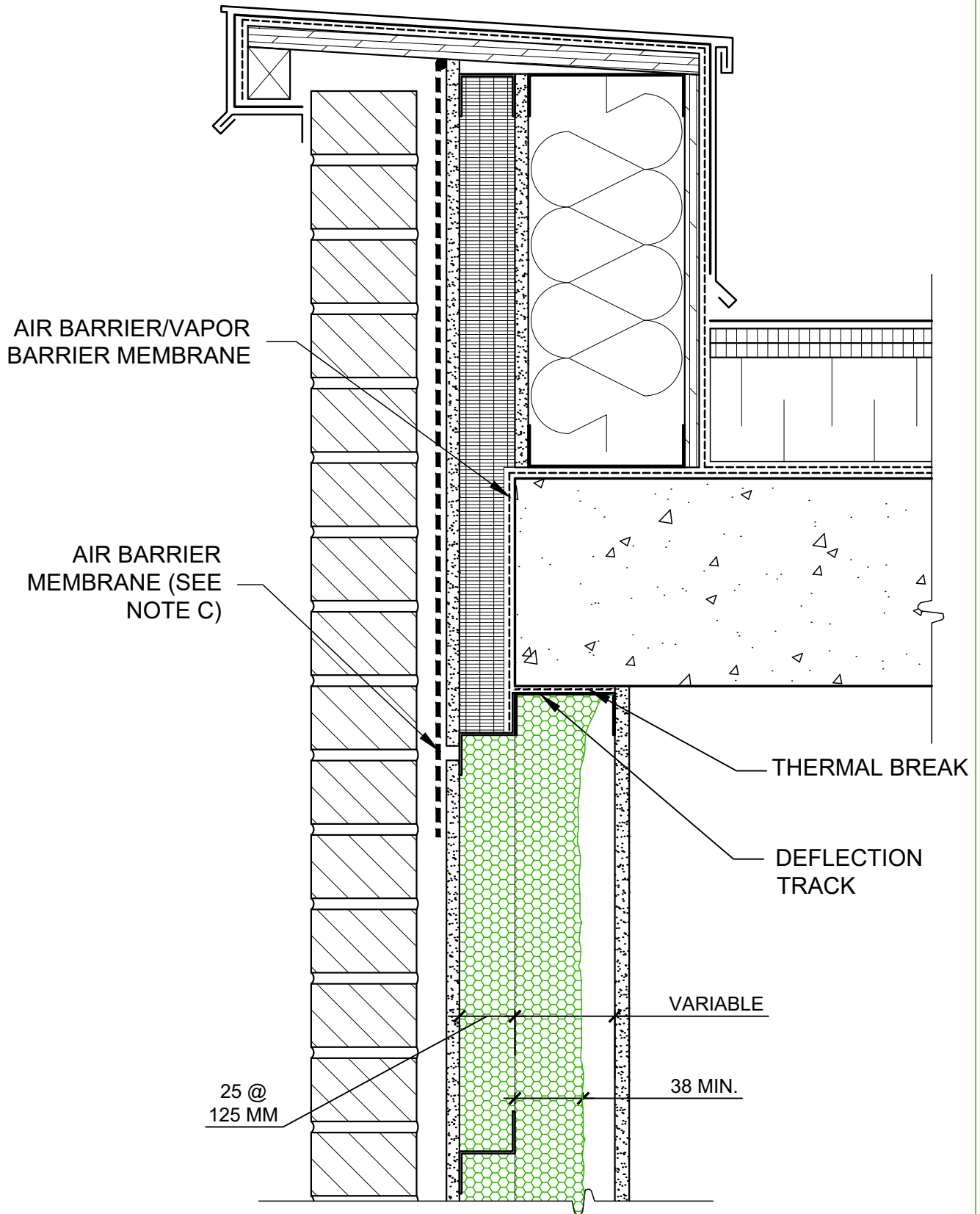

DETAIL AT SUPPORT BEAM, PARAPET  
BRICK SIDING

Date: 03-05-2022

SCALE : 1:5



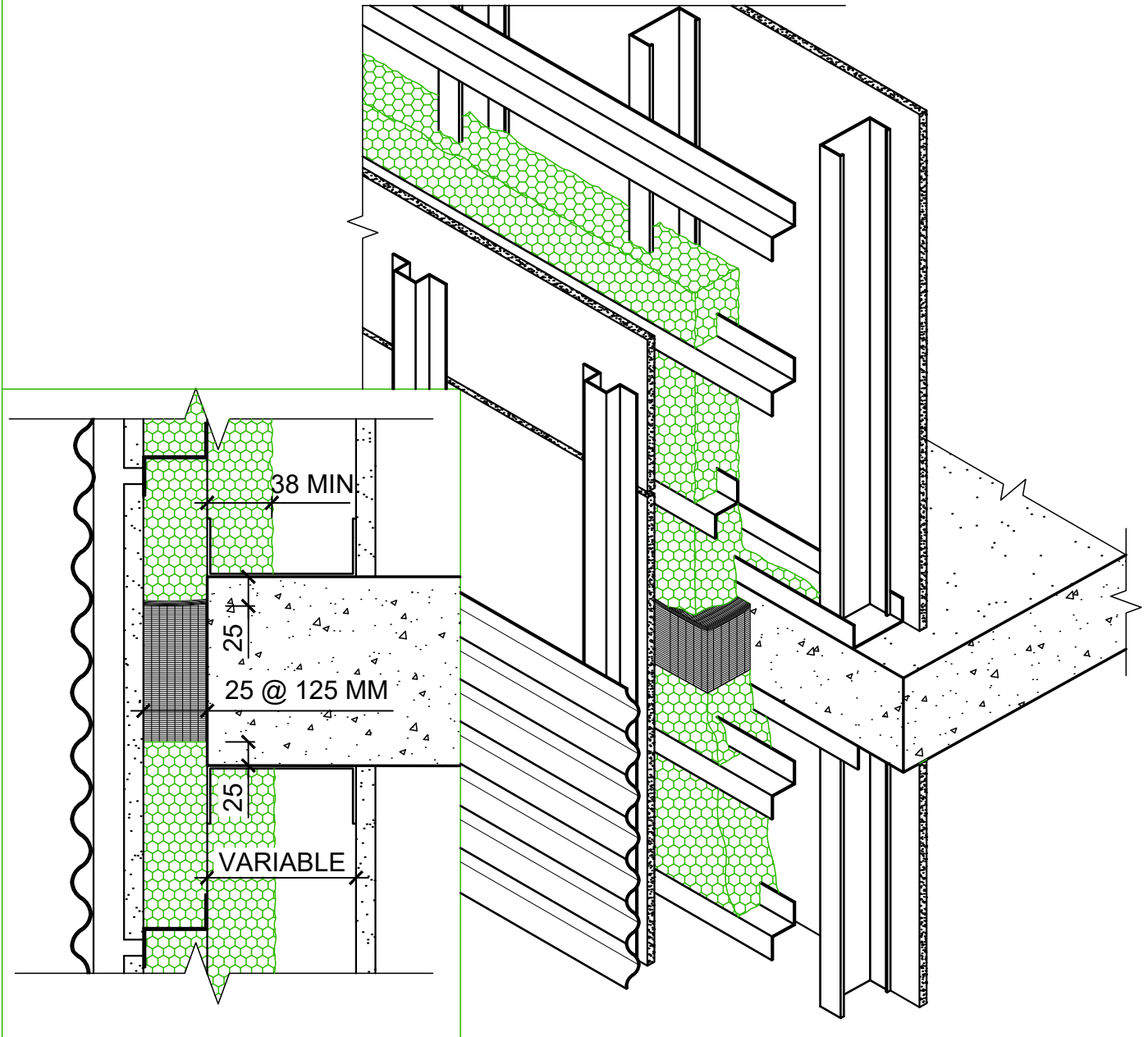

ISOMETRY  
LIGHTWEIGHT SIDING

Date:03-05-2022

Scale: Variable

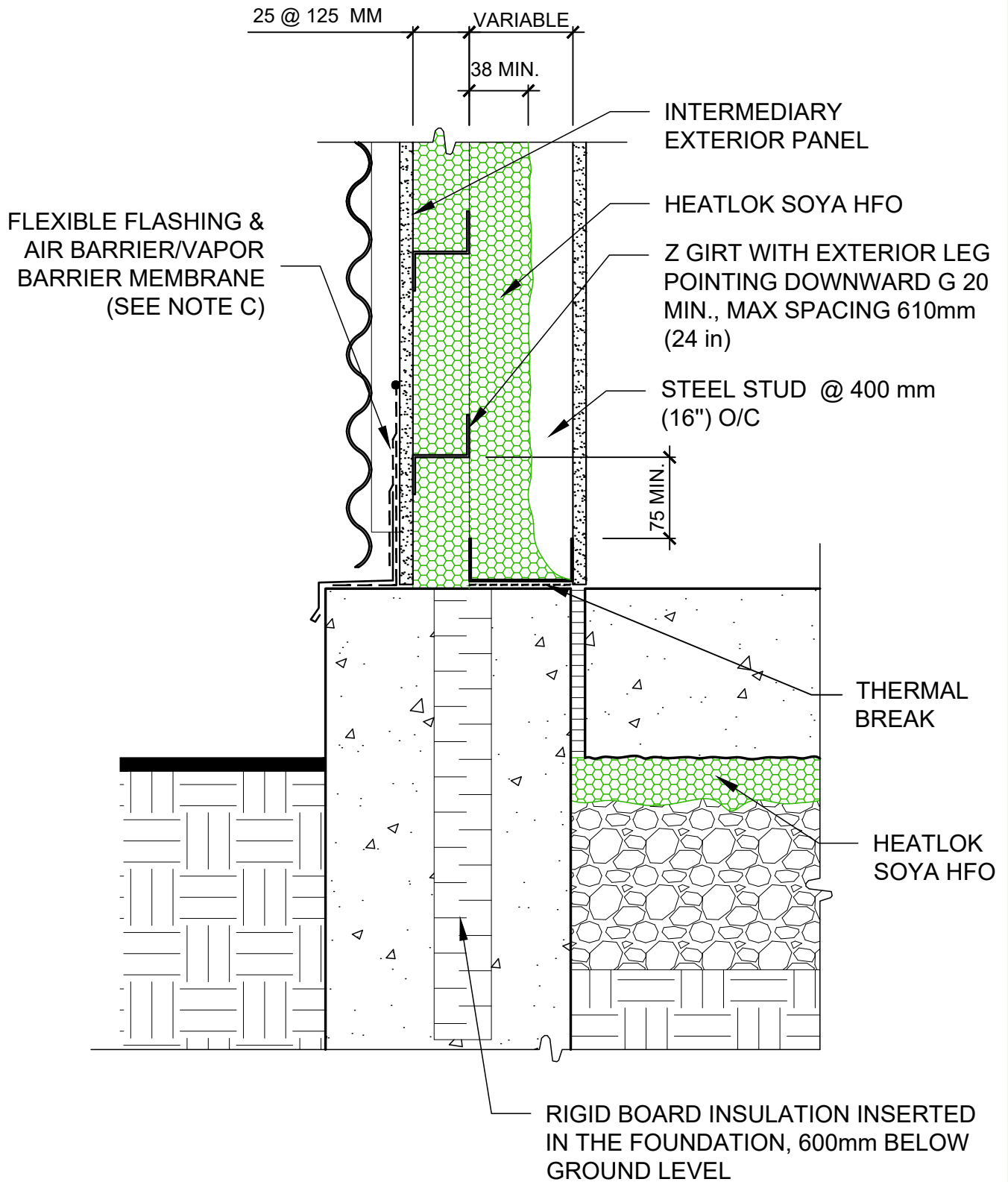

THROUGH WALL MEMBRANE AT FOUNDATION  
WALL JUNCTION - LIGHTWEIGHT SIDING

Date: 03-05-2022

SCALE : 1:5

ONE COMPONENT PORTABLE  
POLYURETHANE FOAM

CAULKING WITH  
BACKER ROD AT  
PERIMETER

AIR BARRIER/VAPOR  
BARRIER MEMBRANE  
(SEE NOTES B & C)

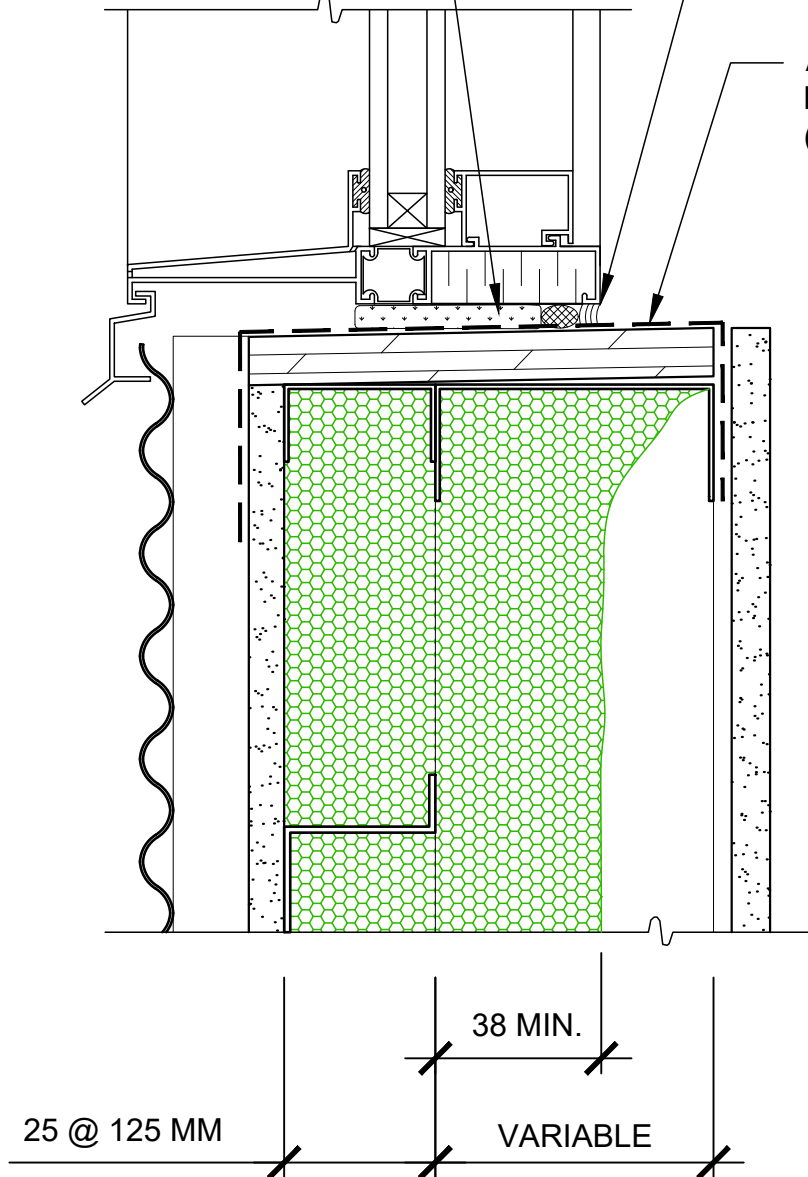

WINDOW SILL  
LIGHTWEIGHT SIDING

Date: 03-05-2022

SCALE: 1:2.5

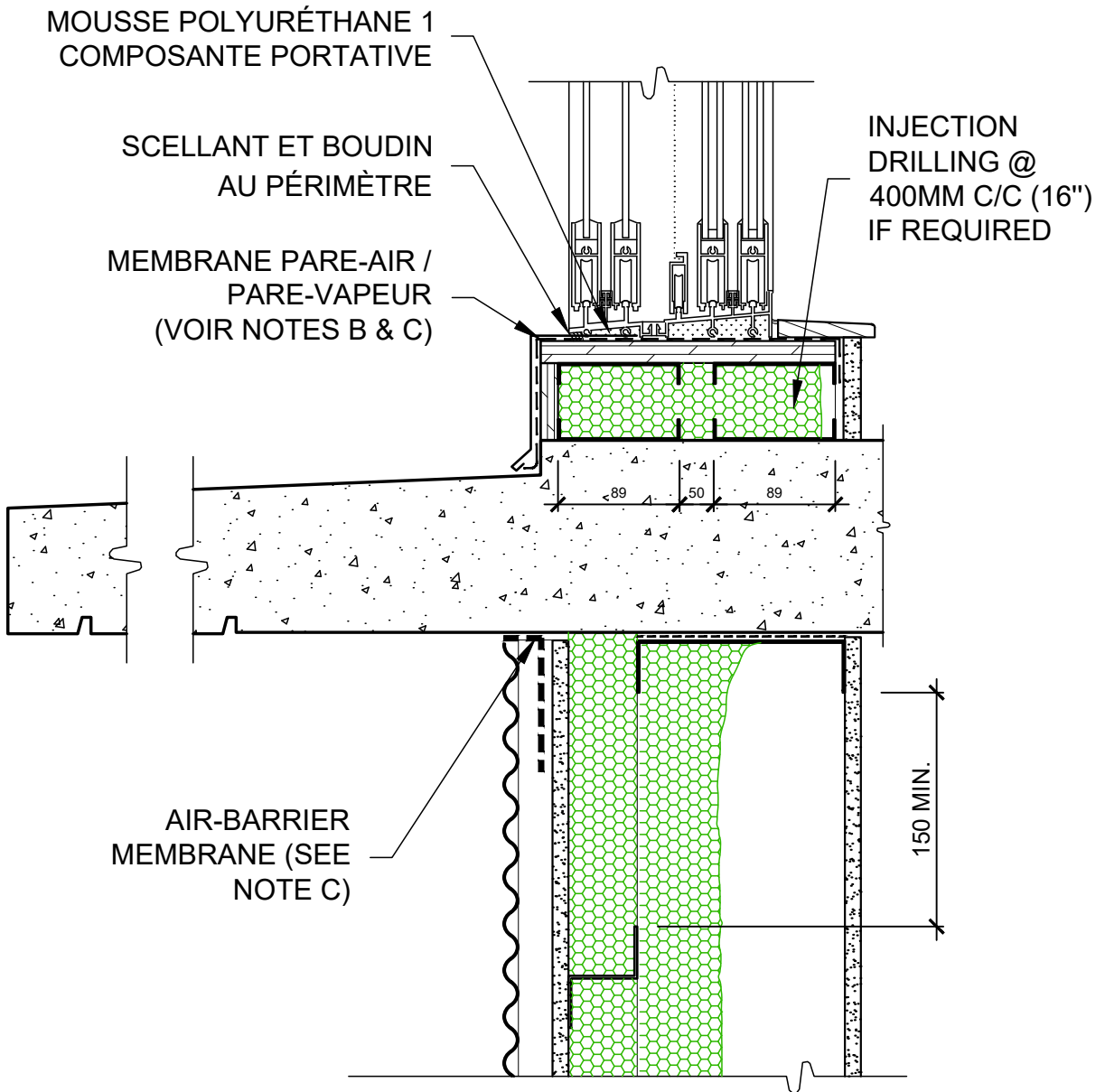

BALCONY/FLOOR SLAB JUNCTION  
LIGHTWEIGHT SIDING

Date: 03-05-2022

Scale: 1:5

NOTE: FOR SUPPORT PURPOSES AT OPENINGS, THE WINDOW SUPPORT POSTS MAY BE DOUBLED AND INJECTED WITH HEATLOK SOYA HFO.

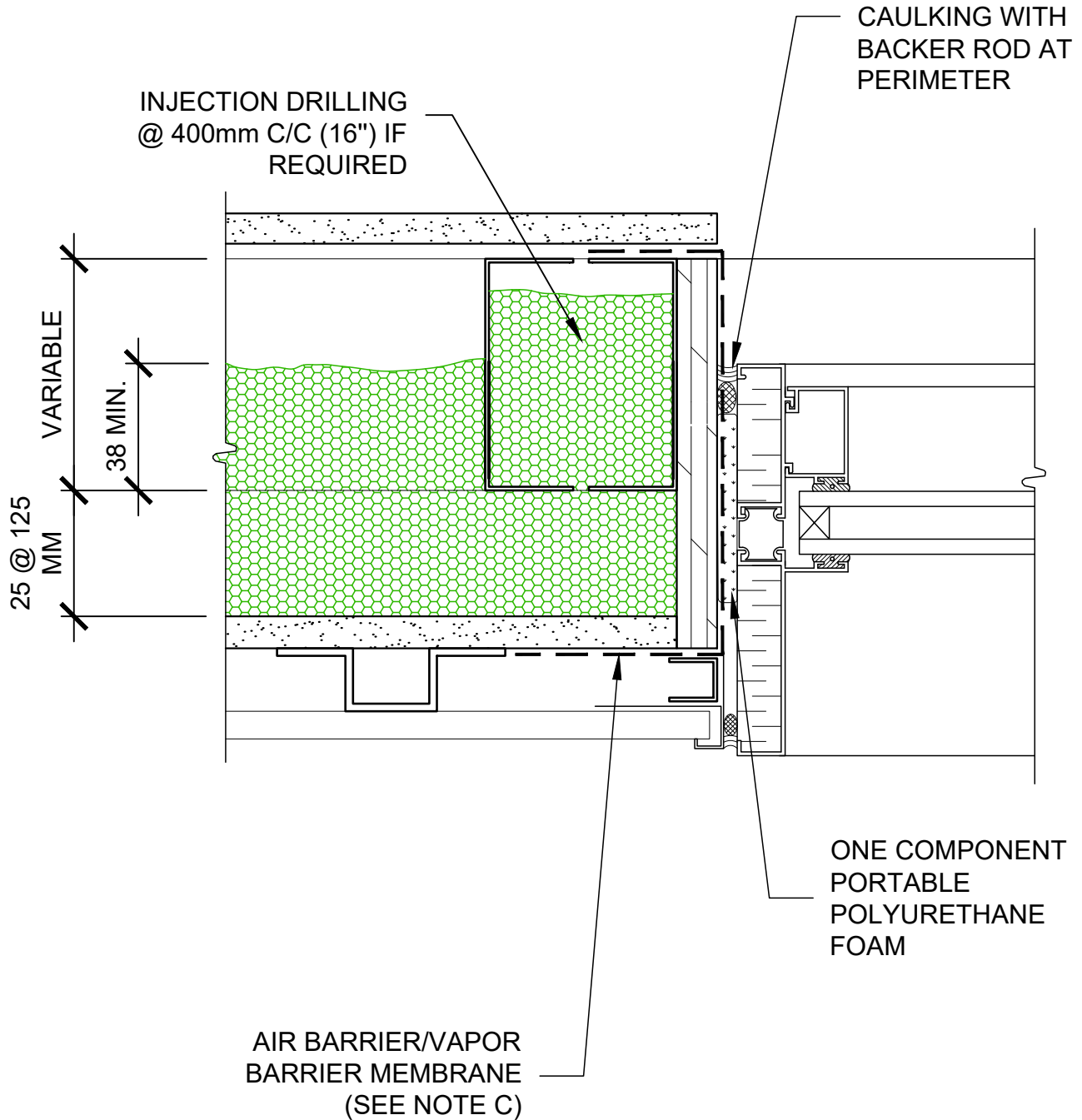

WINDOW JAMB  
LIGHTWEIGHT SIDING

Date: 03-05-2022

SCALE: 1:2.5



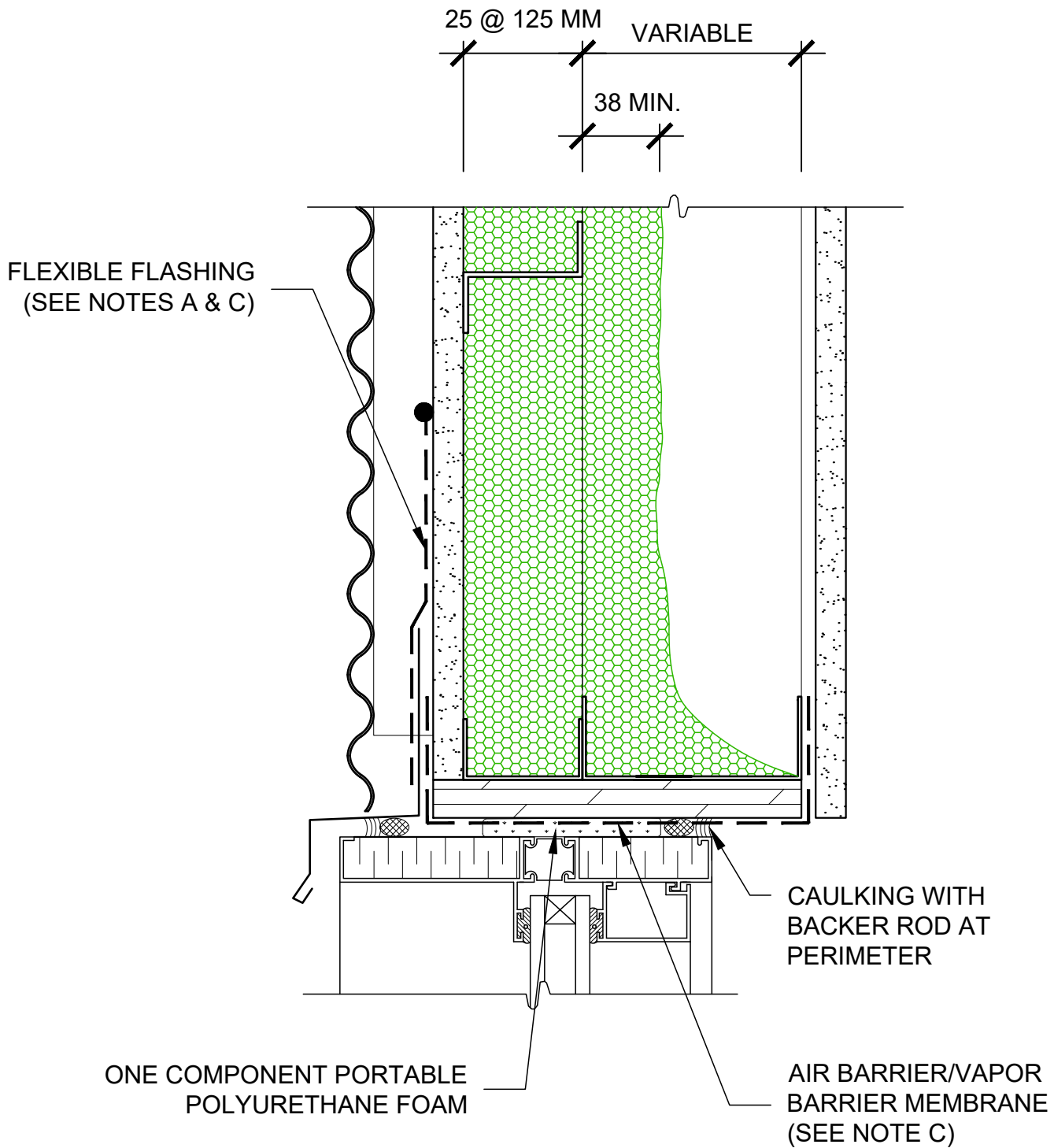

TOP OF WINDOW  
LIGHTWEIGHT SIDING

Date: 03-05-2022

SCALE: 1:2.5

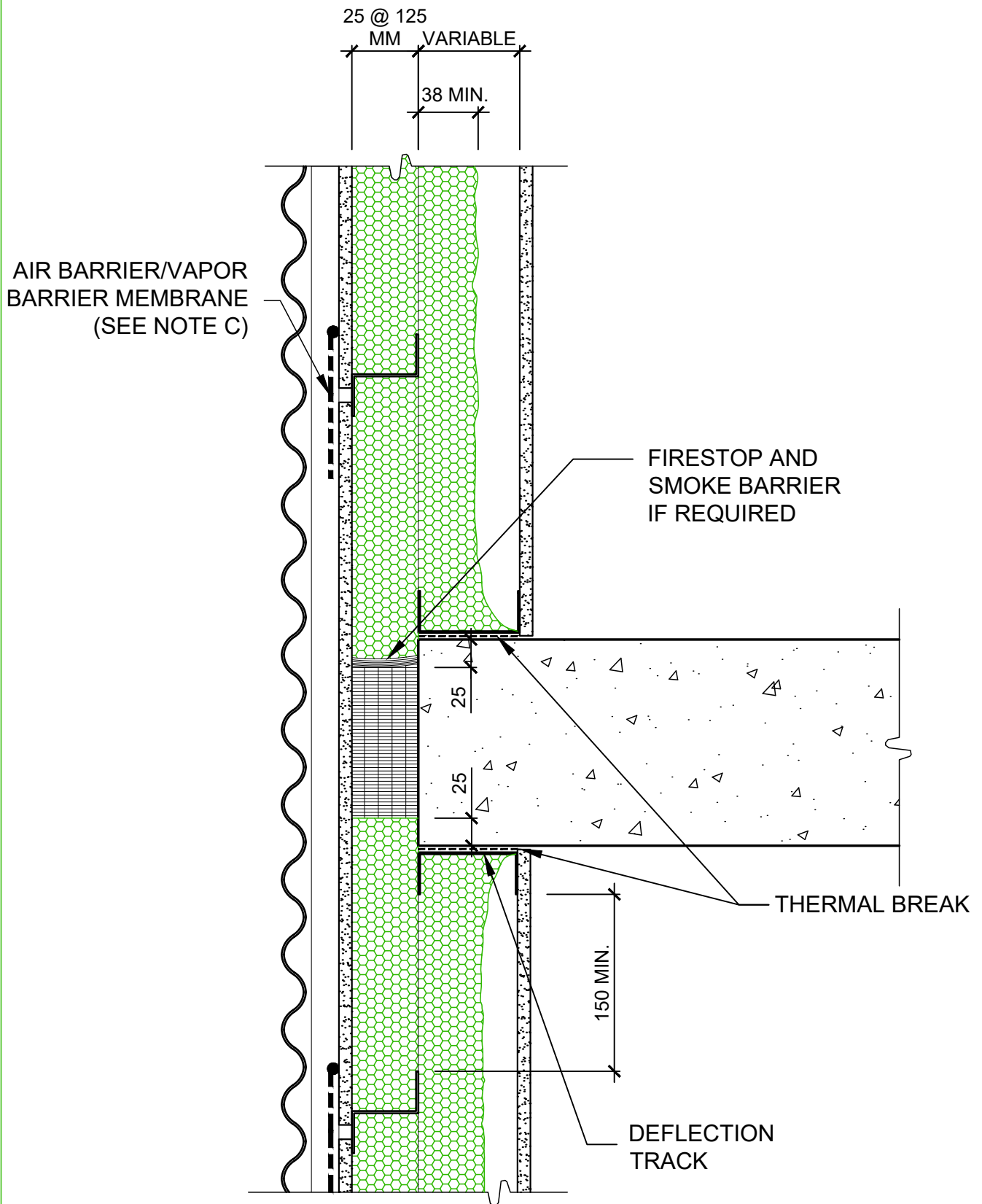

FLOOR JUNCTION  
LIGHTWEIGHT SIDING

Date: 03-05-2022

SCALE : 1:5

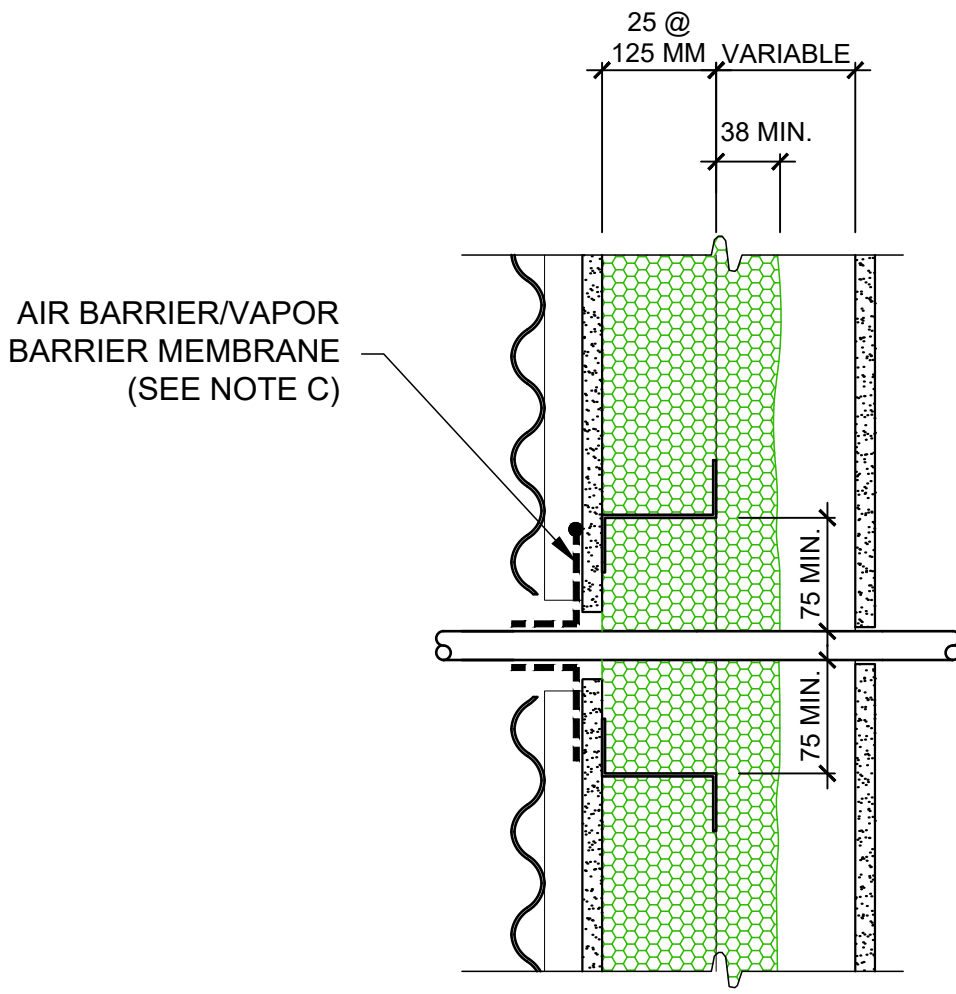

DETAIL AT WALL PENETRATION  
 LIGHTWEIGHT SIDING

Date: 03-05-2022

SCALE : 1:5

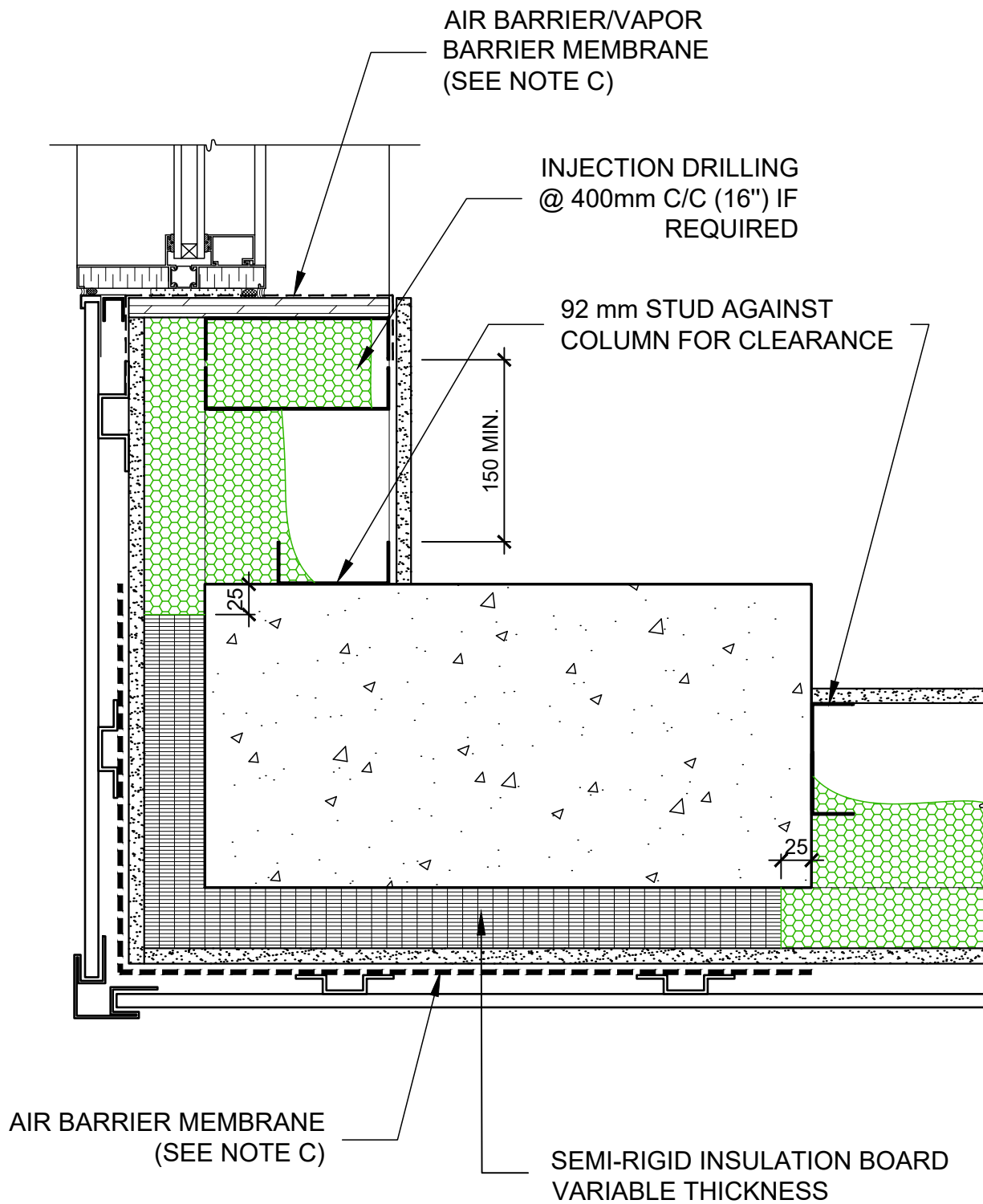

COLUMN AND WALL JUNCTION - BUILDING CORNER  
 LIGHTWEIGHT SIDING

Date: 03-05-2022

SCALE : 1:5

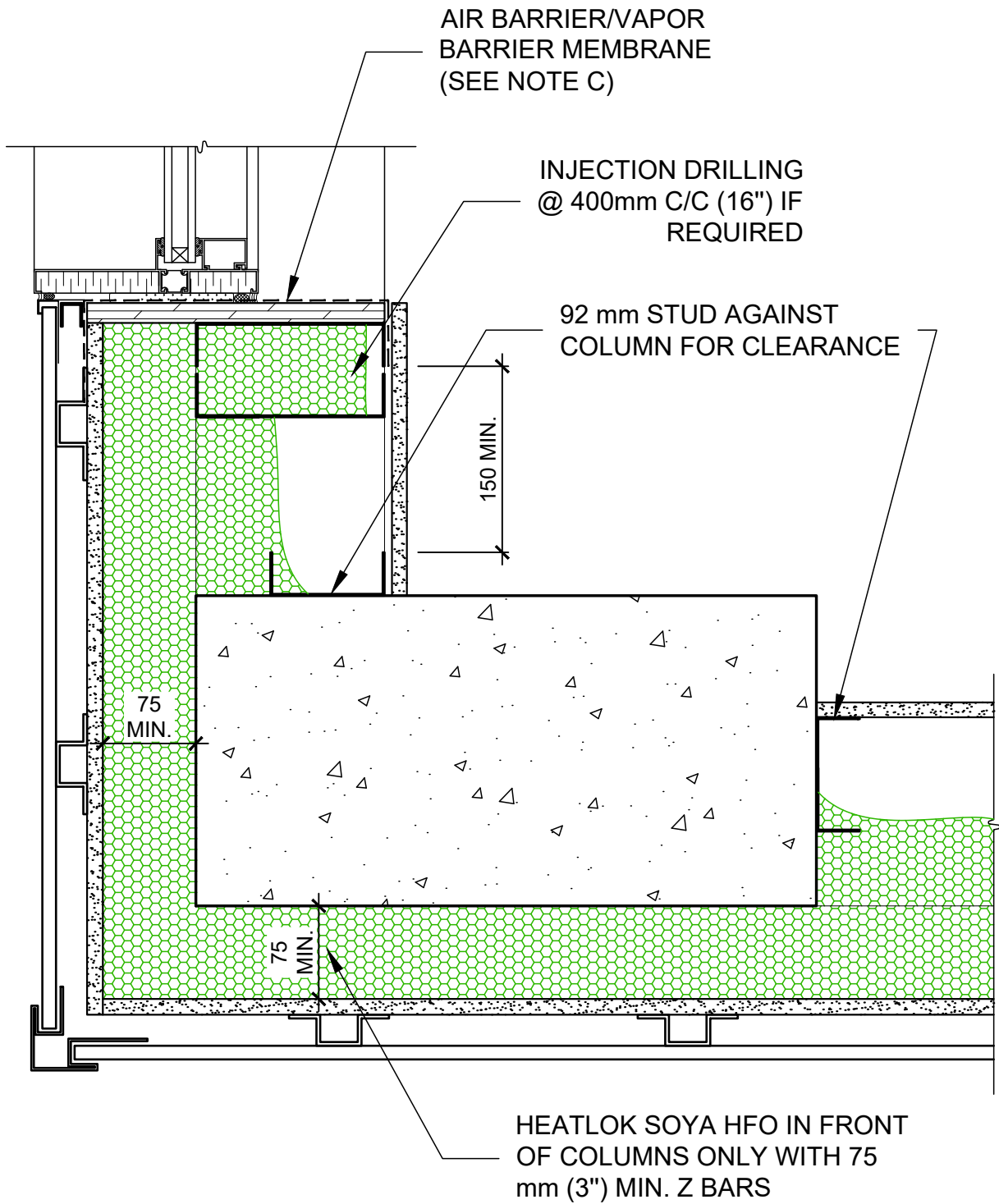

COLUMN AND WALL JUNCTION - BUILDING CORNER  
LIGHTWEIGHT SIDING

Date: 03-05-2022

SCALE : 1:5



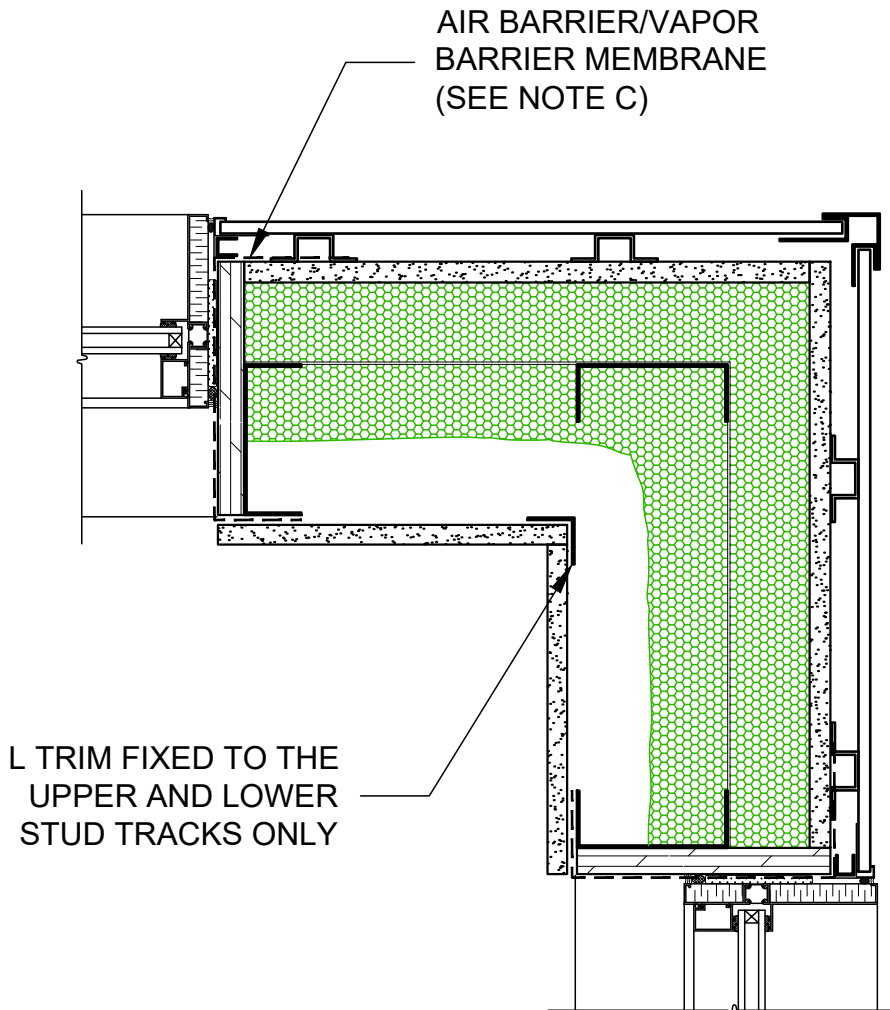

BUILDING CORNER STUD PLACEMENT  
LIGHTWEIGHT SIDING

Date: 03-05-2022

SCALE : 1:5

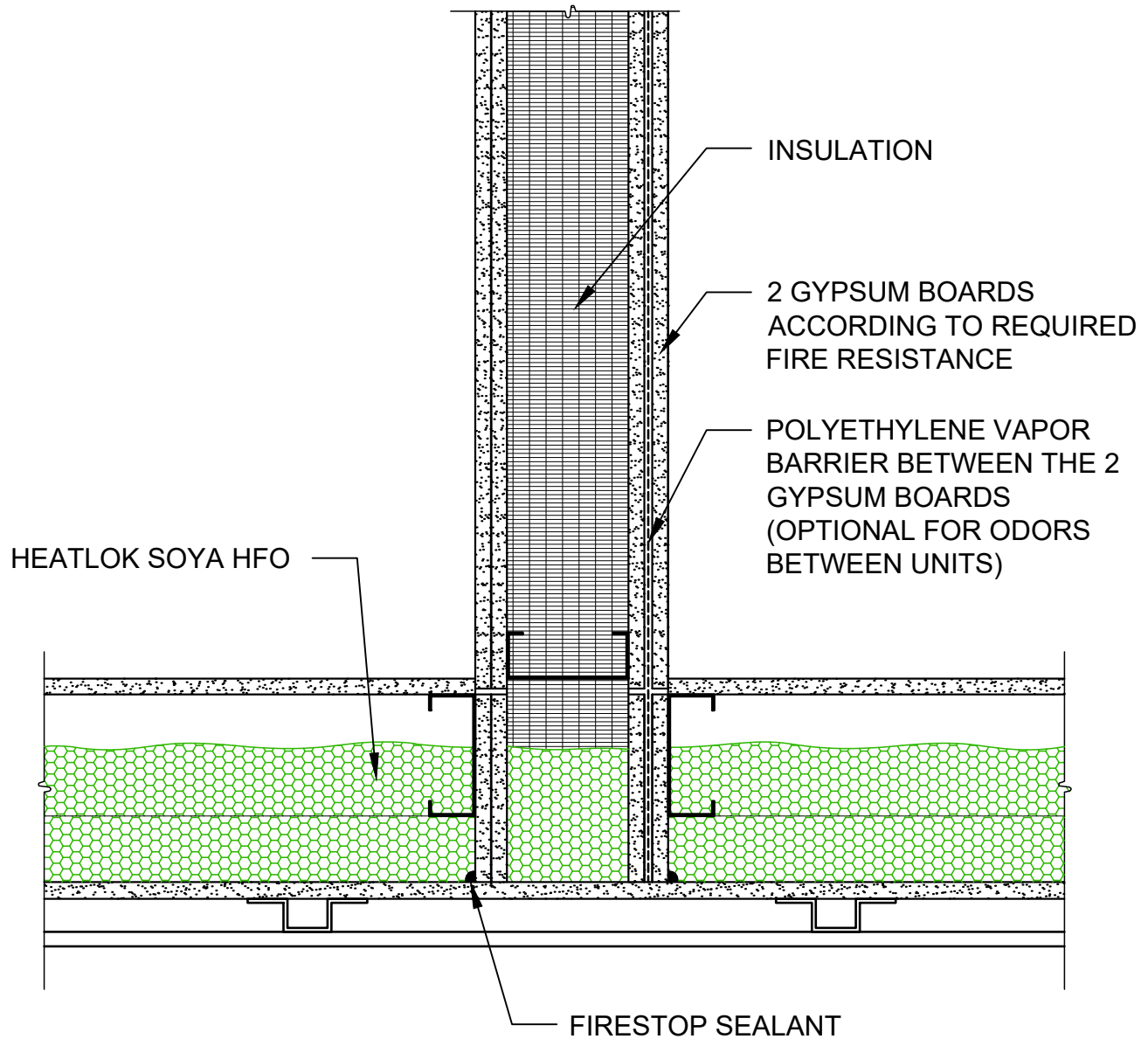

FIRE SEPARATION  
LIGHTWEIGHT SIDING

Date: 03-05-2022

SCALE : 1:5

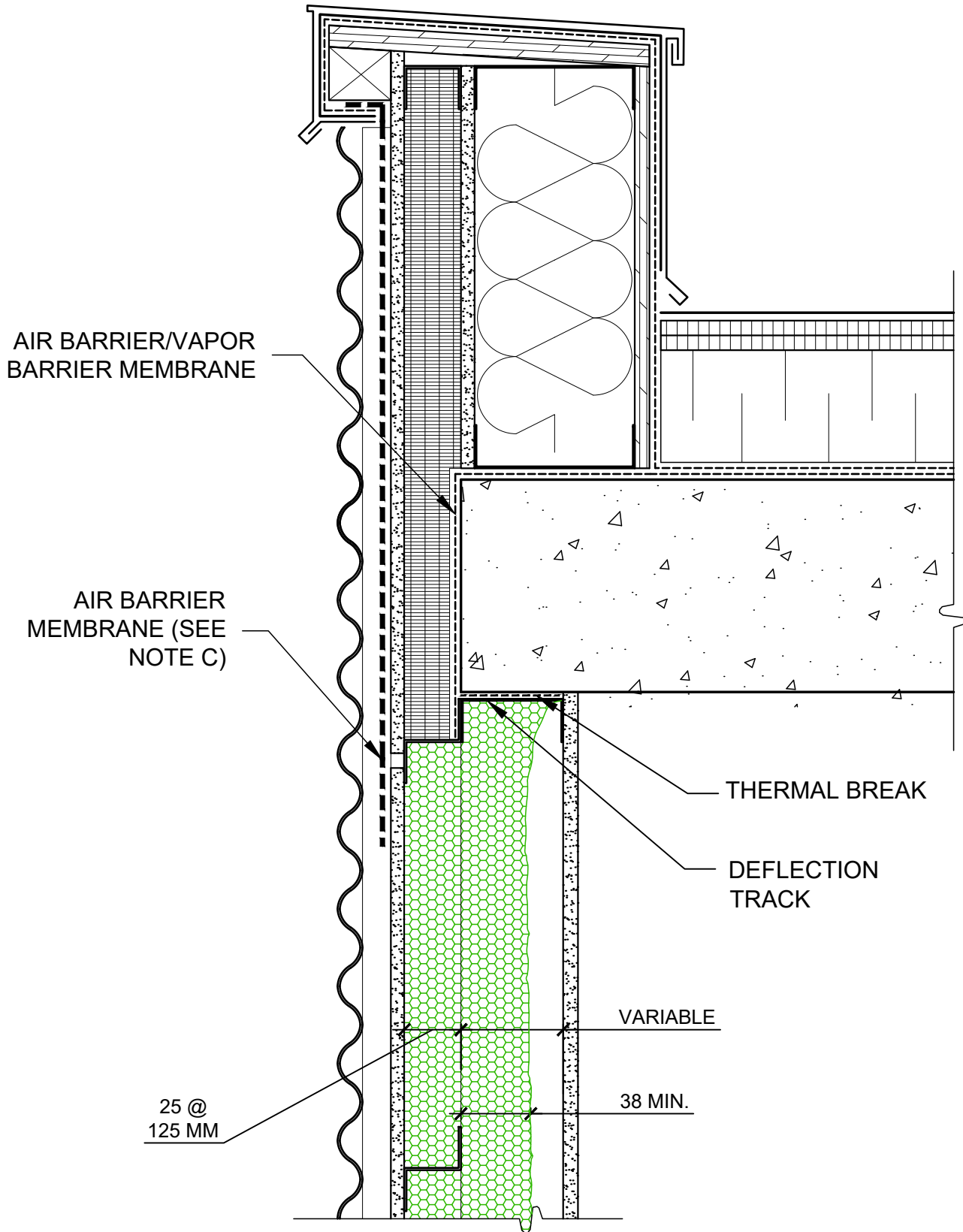

DETAIL AT SUPPORT BEAM, PARAPET  
LIGHTWEIGHT SIDING

Date: 03-05-2022

SCALE : 1:5

# OPTIONS

Date: 03-05-2022

OPTION

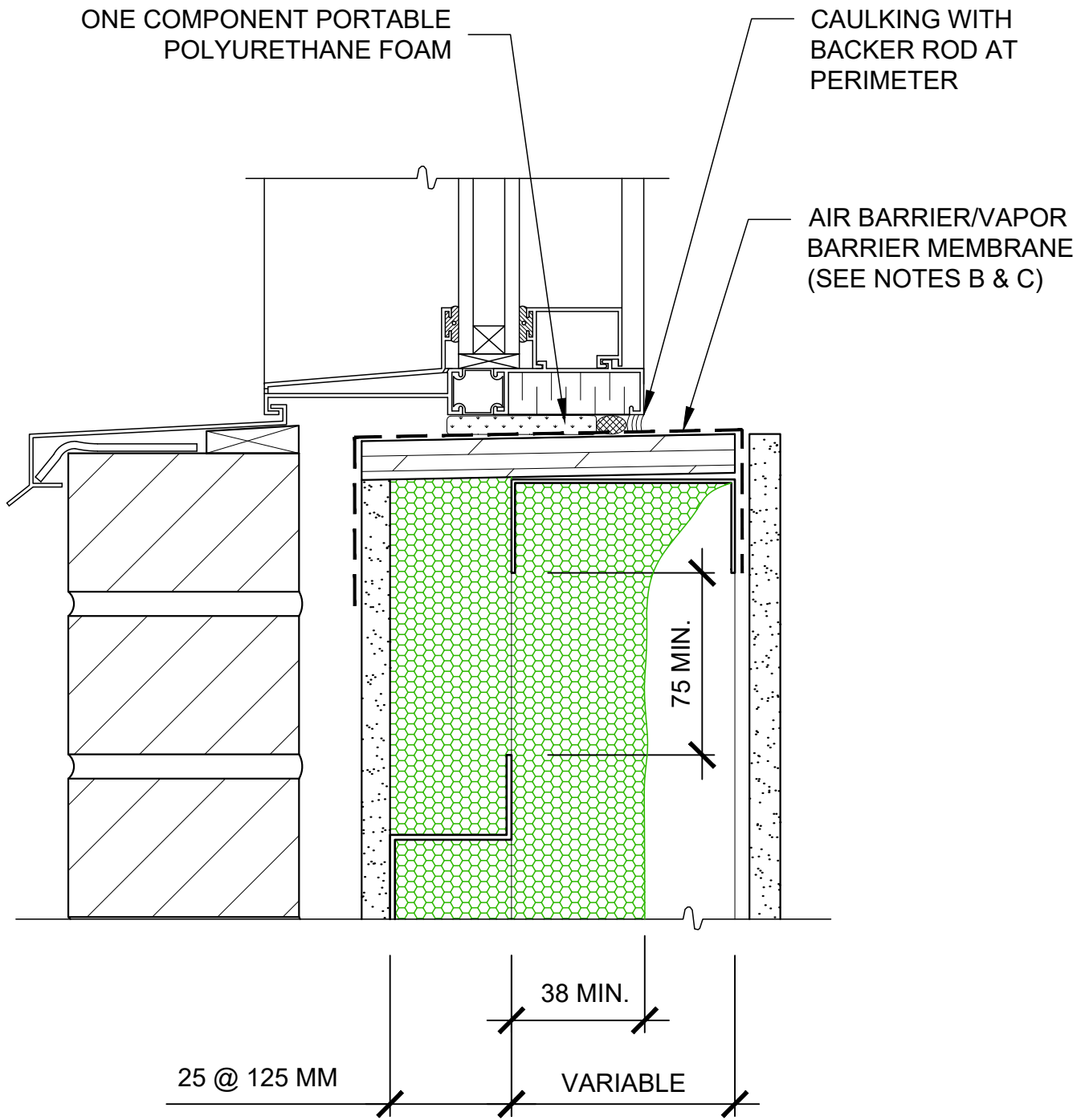

WINDOW SILL  
BRICK SIDING

Date: 03-05-2022

SCALE: 1:2.5



NOTE: FOR SUPPORT PURPOSES AT OPENINGS, THE WINDOW SUPPORT POSTS MAY BE DOUBLED AND INJECTED WITH HEATLOK SOYA HFO.

OPTION

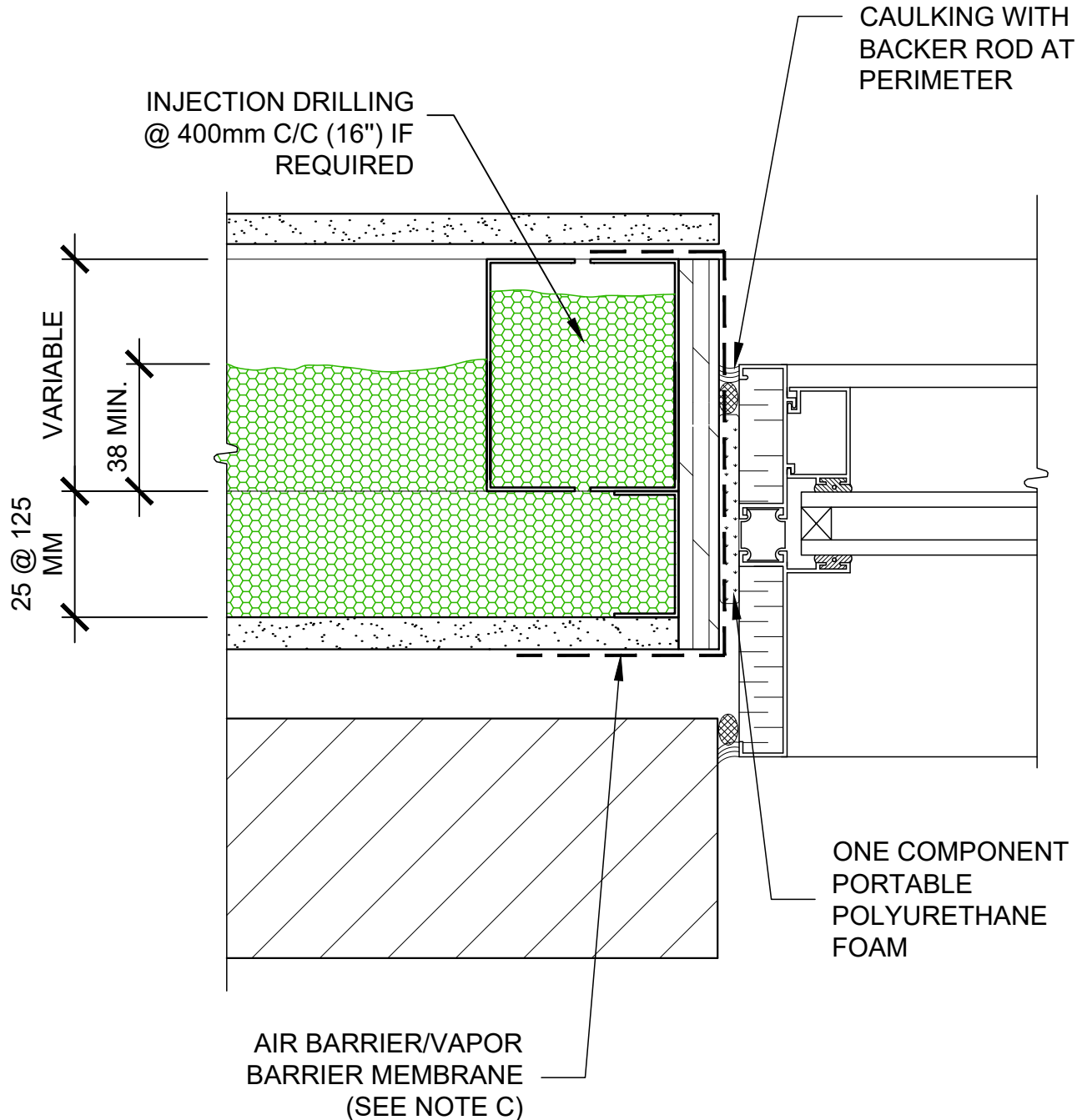

WINDOW JAMB  
BRICK SIDING

Date: 03-05-2022

SCALE: 1:2.5

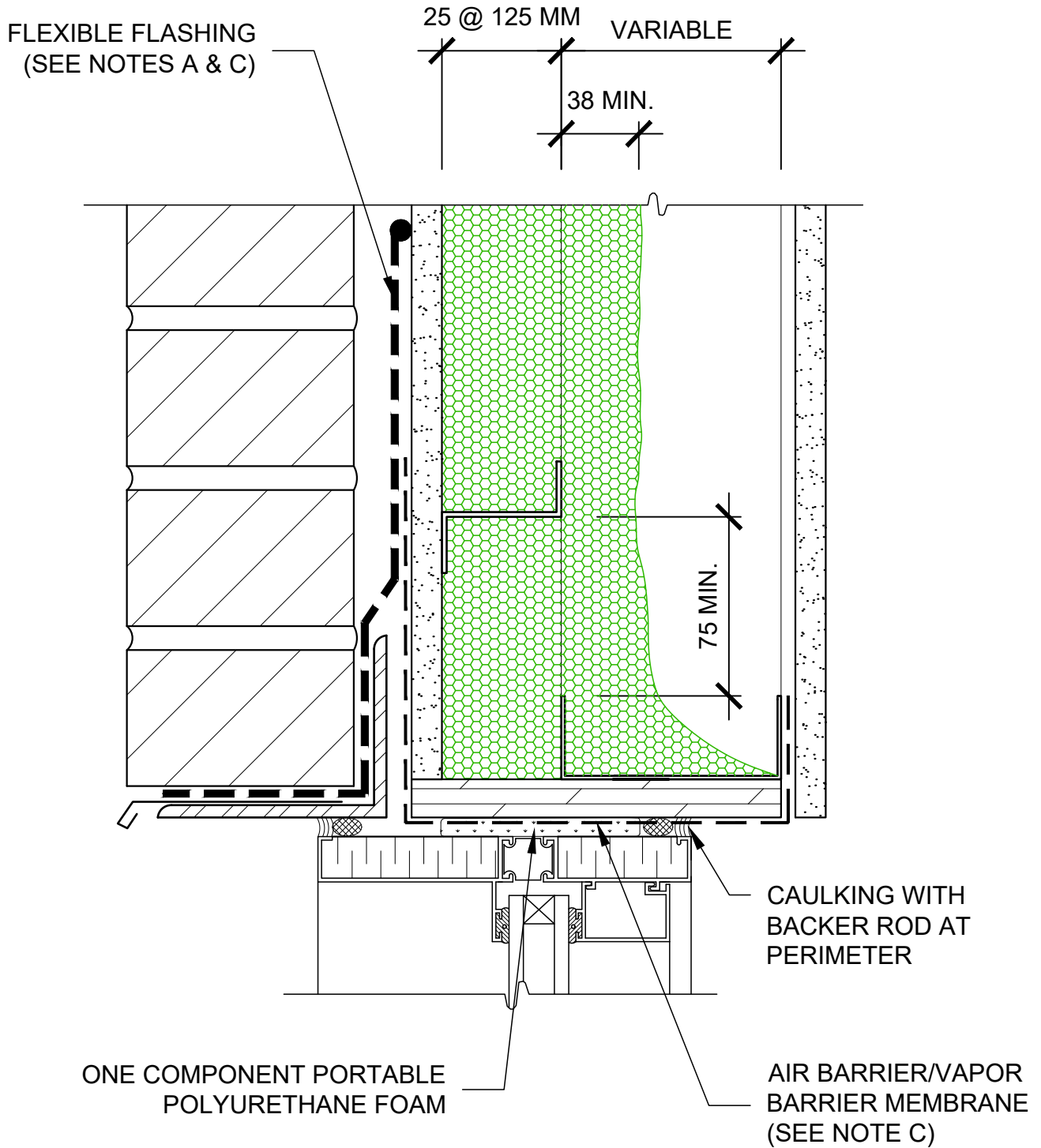

TOP OF WINDOW  
BRICK SIDING

Date: 03-05-2022

SCALE: 1:2.5

OPTION

ONE COMPONENT PORTABLE  
POLYURETHANE FOAM

CAULKING WITH  
BACKER ROD AT  
PERIMETER

AIR BARRIER/VAPOR  
BARRIER MEMBRANE  
(SEE NOTES B & C)

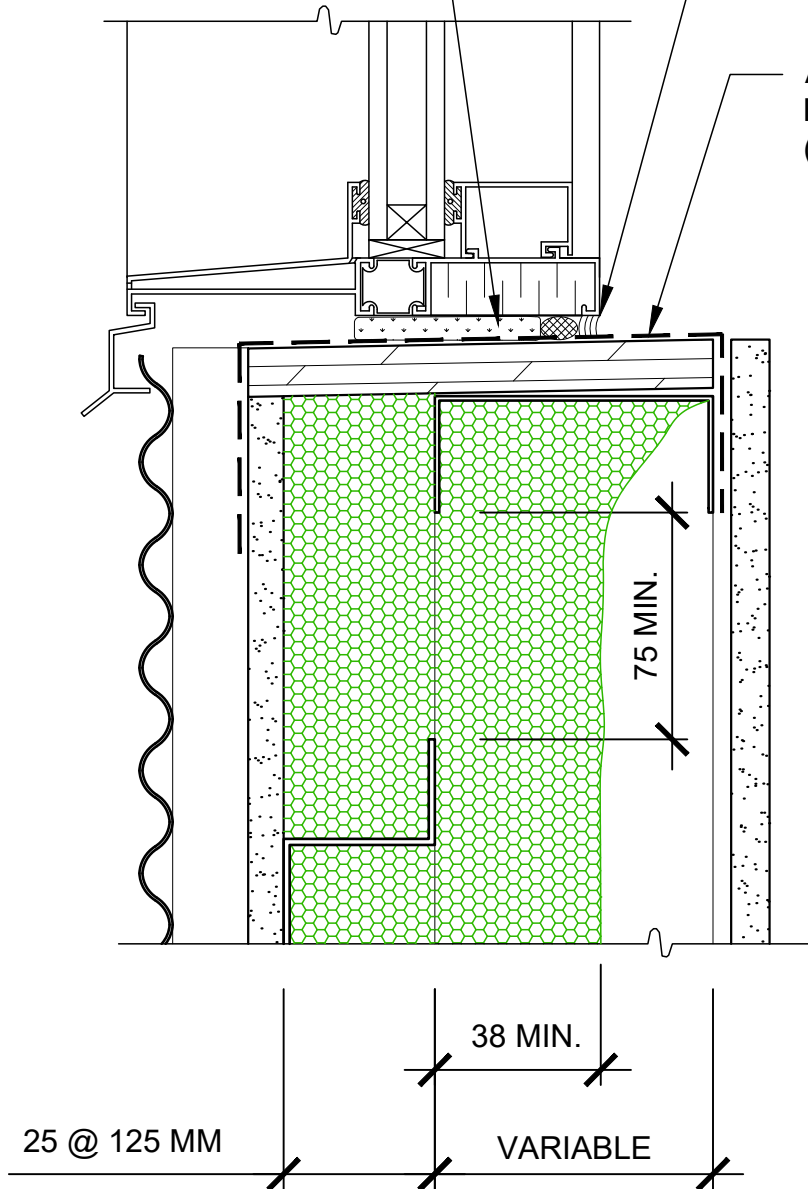

WINDOW SILL  
LIGHTWEIGHT SIDING

Date: 03-05-2022

SCALE: 1:2.5

NOTE: FOR SUPPORT PURPOSES AT OPENINGS, THE WINDOW SUPPORT POSTS MAY BE DOUBLED AND INJECTED WITH HEATLOK SOYA HFO.

OPTION

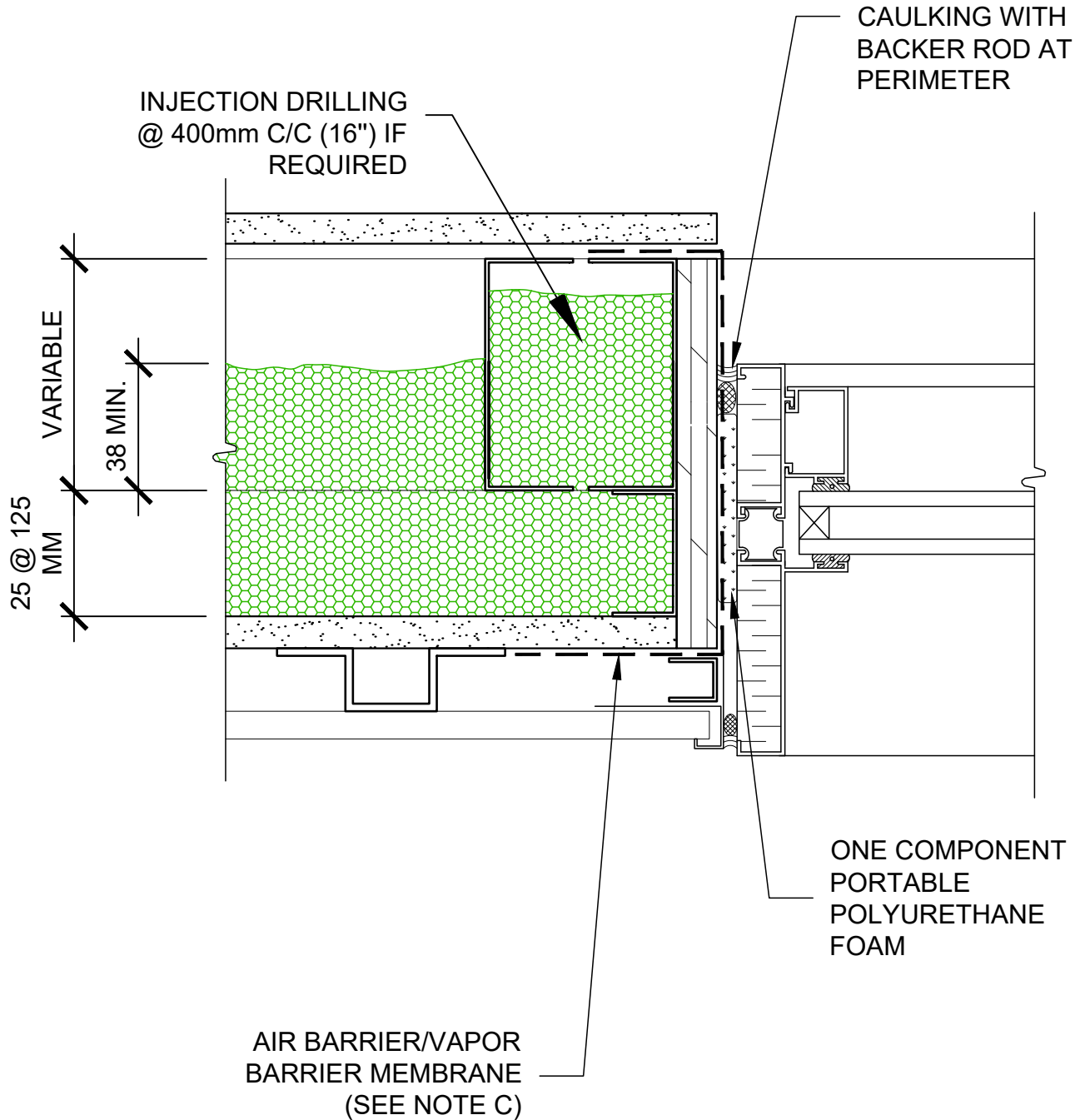

WINDOW JAMB  
LIGHTWEIGHT SIDING

Date: 03-05-2022

SCALE: 1:2.5

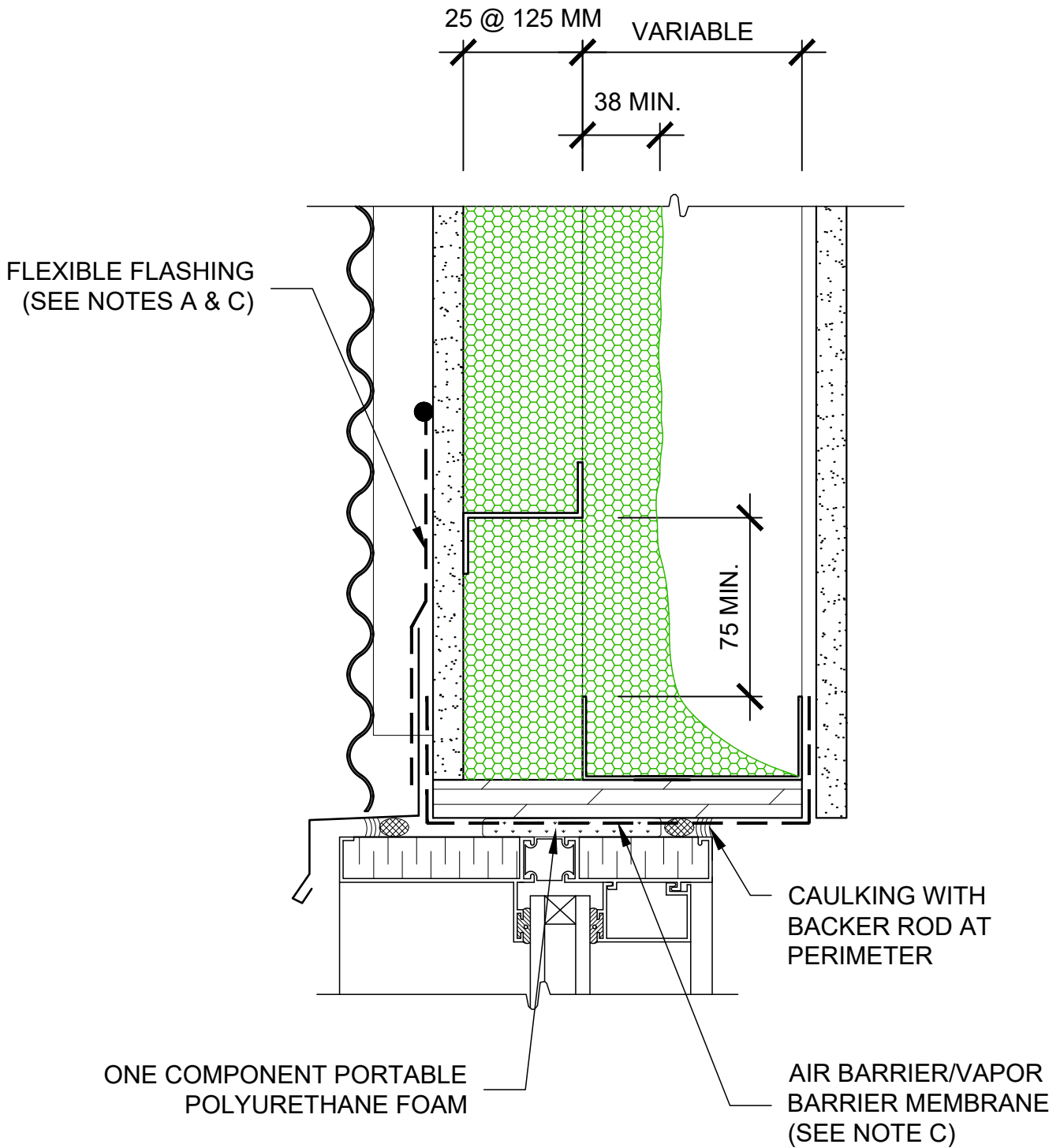

TOP OF WINDOW  
LIGHTWEIGHT SIDING

Date: 03-05-2022

SCALE: 1:2.5



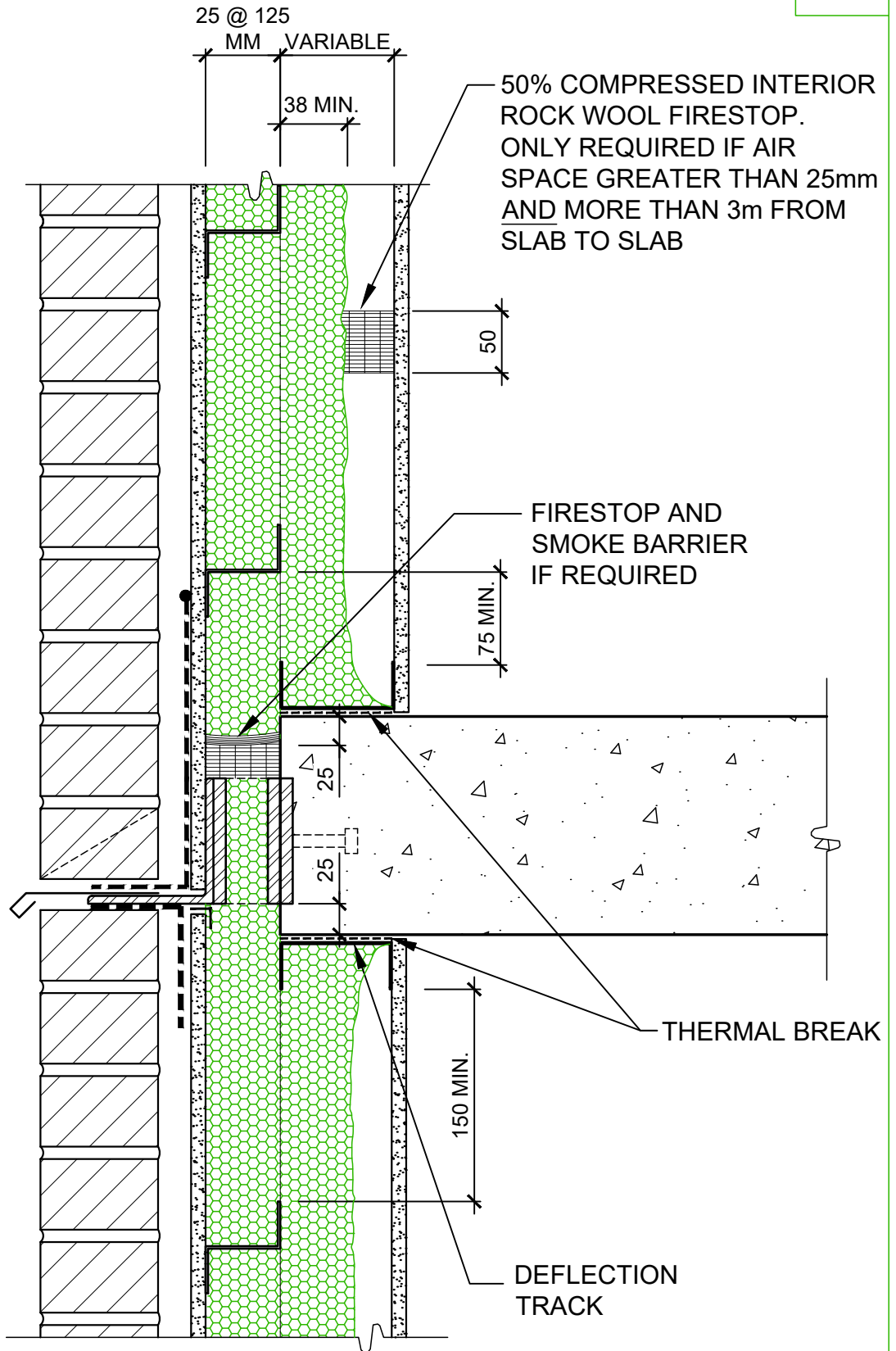

FLOOR JUNCTION  
BRICK SIDING

Date: 03-05-2022

SCALE : 1:5

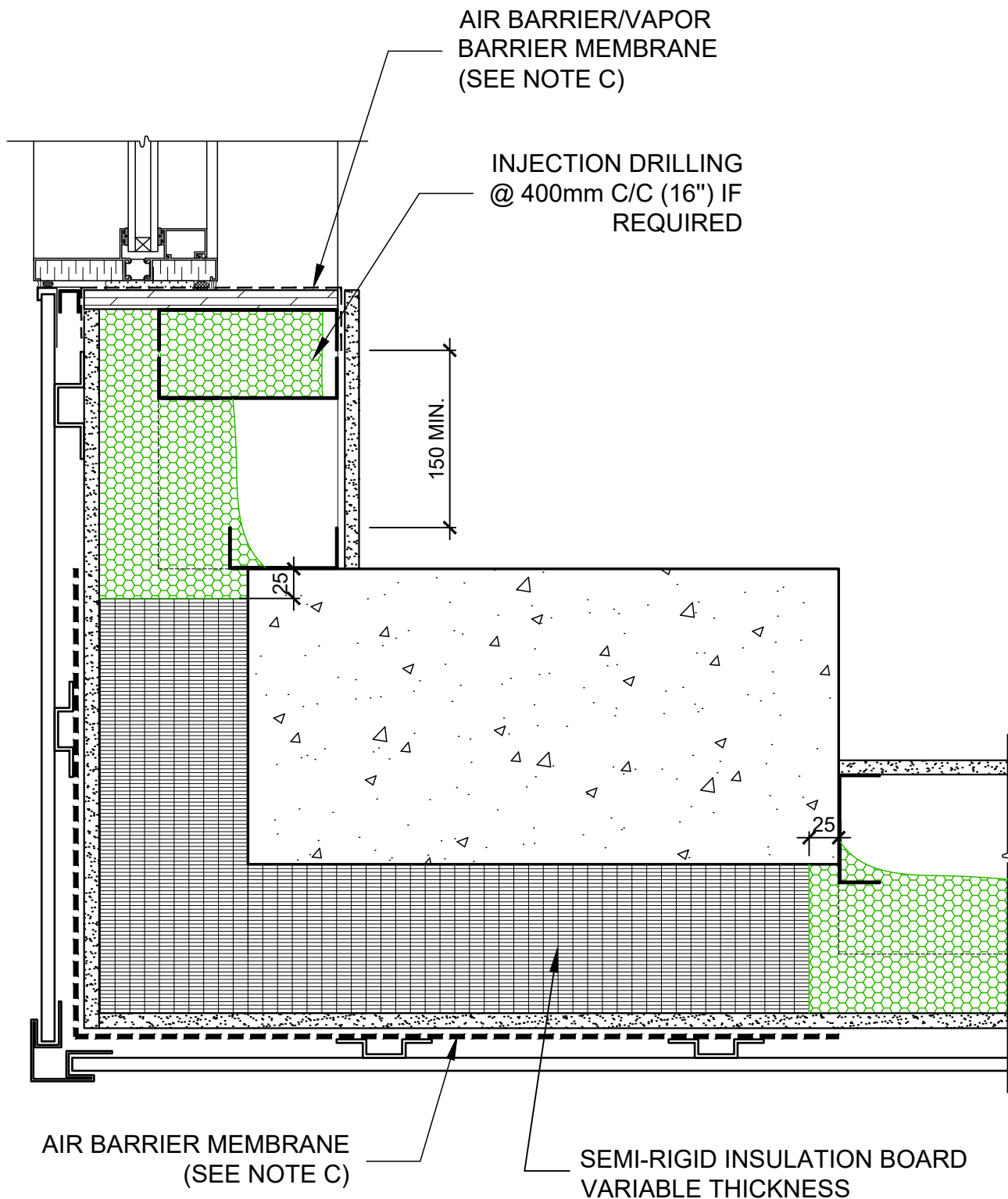

COLUMN AND WALL JUNCTION - BUILDING CORNER  
LIGHTWEIGHT SIDING

Date: 03-05-2022

SCALE : 1:5

August 28<sup>th</sup> 2019

A/S Maxime Duzyk  
Demilec  
870, Curé Boivin  
Boisbriand, Québec  
J7G 2A7

**Project: Z Bar wall section -- Demilec**

As per your request and our discussions, you will find below our preliminary recommendation concerning the required Z bar thickness spaced at 24" c/c for different depth that varies from 1" to 5".

Design dead load: 6 lb/ft<sup>2</sup>

- Steel cladding: 1.5 lb/ft<sup>2</sup>
- 5/8" Glasroc pannel: 2.5 lb/ft<sup>2</sup>
- Omega bar: 0.5 lb/ft<sup>2</sup>
- Z bar: 0.5 lb/ft<sup>2</sup>
- Insulation: 1.0 lb/ft<sup>2</sup>

Z bar thickness required according to depth

- Depth from 1" to 2" : 20 gage required (0.0359")
- Depth from 2" to 3 1/2" : 18 gage required (0.0478")
- Depth from 3 1/2" to 5" : 16 gage required (0.0598")

These recommendations must be confirmed by the project stud wall structural engineer. He has to consider the project wind load acting on walls and dead load. The calculation of Z bar connexion to stud wall is the responsibility of the project stud wall structural engineer.

If you have any question, do not hesitate to contact the undersigned.



Ronald Beaucage eng.  
Beaucage Experts-Conseils

## D-Max Wall Assembly - Thermal Resistance in accordance with ASTM C1363 and ASHRAE 1365-RP

Climate Zones	Ontario U-Value Requirements			
	Imperial		Metric	
	Residential	Non-Residential	Residential	Non-Residential
5	0.055	0.055	0.31	0.31
6	0.055	0.055	0.31	0.31
7	0.037	0.055	0.21	0.31

D-Max Wall Assembly - Thermal Resistance - Heatlok Soya HFO									
Z-Bar Thickness		Z-Bar Spacing		Total Thickness of Heatlok Soya HFO		Effective Thermal Resistance		U-Value	
Inches	mm	Inches	mm	Inches	mm	R	RSI	Imperial	Metric
3"	75	24" c/c	600 c/c	4.5	114.3	19.7	3.47	0.051	0.288
				5	127	20.7	3.65	0.048	0.274
				6	152.4	22.4	3.94	0.045	0.254
				6.5	165.1	23.2	4.08	0.043	0.245
				7.5	190.5	25	4.41	0.040	0.227
		16" c/c	400 c/c	4.94	125.4	17.8	3.14	0.056	0.318
				5.92	150.4	19.2	3.39	0.052	0.295
				6.75	171.5	20.4	3.59	0.049	0.279
				7	177.8	20.9	3.68	0.048	0.272
				8.5	215.9	23.3	4.11	0.043	0.243
2.25"	57	24" c/c	600 c/c	3.75	95.3	17.8	3.13	0.056	0.319
				5.5	139.7	20.7	3.65	0.048	0.274
				6	152.4	21.5	3.79	0.047	0.264
				7	177.8	23	4.05	0.043	0.247
				7.5	190.5	23.8	4.2	0.042	0.238
		16" c/c	400 c/c	3.75	95.3	15.6	2.75	0.064	0.364
				6	152.4	18.9	3.33	0.053	0.303
				7.25	184.2	20.7	3.64	0.048	0.262
				8	203.2	21.7	3.82	0.046	0.262
				9	228.6	24.3	4.28	0.041	0.234

- \* With generic exterior finish (exterior finish has negligible impact on the results)
- \* Steel studs @ 16" c/c (the thickness of the framing has negligible impact on the results)
- \* Values for opaque wall only



## D-Max Wall Assembly - Thermal Resistance in accordance with ASTM C1363 and ASHRAE 1365-RP

Climate Zones	Quebec Effective Thermal Resistance Requirements	
	R	RSI
6000 degree days and less	20.44	3.60
More than 6000 degree days	22.99	4.05

D-Max Wall Assembly - Thermal Resistance - Heatlok Soya HFO									
Z-Bar Thickness		Z-Bar Spacing		Total Thickness of Heatlok Soya HFO		Effective Thermal Resistance		U-Value	
Inches	mm	Inches	mm	Inches	mm	R	RSI	Imperial	Metric
3"	75	24" c/c	600 c/c	4.5	114.3	19.7	3.47	0.051	0.288
				5	127	20.7	3.65	0.048	0.274
				6	152.4	22.4	3.94	0.045	0.254
				6.5	165.1	23.2	4.08	0.043	0.245
				7.5	190.5	25	4.41	0.040	0.227
		16" c/c	400 c/c	4.94	125.4	17.8	3.14	0.056	0.318
				5.92	150.4	19.2	3.39	0.052	0.295
				6.75	171.5	20.4	3.59	0.049	0.279
				7	177.8	20.9	3.68	0.048	0.272
				8.5	215.9	23.3	4.11	0.043	0.243
2.25"	57	24" c/c	600 c/c	3.75	95.3	17.8	3.13	0.056	0.319
				5.5	139.7	20.7	3.65	0.048	0.274
				6	152.4	21.5	3.79	0.047	0.264
				7	177.8	23	4.05	0.043	0.247
				7.5	190.5	23.8	4.2	0.042	0.238
		16" c/c	400 c/c	3.75	95.3	15.6	2.75	0.064	0.364
				6	152.4	18.9	3.33	0.053	0.303
				7.25	184.2	20.7	3.64	0.048	0.262
				8	203.2	21.7	3.82	0.046	0.262
				9	228.6	24.3	4.28	0.041	0.234

\* With generic exterior finish (exterior finish has negligible impact on the results)

\* Steel studs @ 16" c/c (the thickness of the framing has negligible impact on the results)

\* Values for opaque wall only

**ASSEMBLY**

- LIGHTWEIGHT SIDING
- HAT CHANNEL 25 MM
- TYVEK FULL SURFACE MEMBRANE OR TRANSITION MEMBRANE AT JOINTS ONLY
- EXTERIOR GYPSUM SHEATHING 12.7MM
- CONTINUOUS HORIZONTAL Z BAR 75MM G 18 @ 610 C/C FIXED WITH SELF-TAPING no.14x1" SCREW @ THE STUDS
- STEEL STUD 90MM @ 406 C/C
- SPF HEATLOK SOYA HFO 125MM SPRAYED BETWEEN THE STUDS AND Z BAR
- AIR CAVITY 40MM
- REG. INTERIOR GYPSUM BOARD 12.7MM

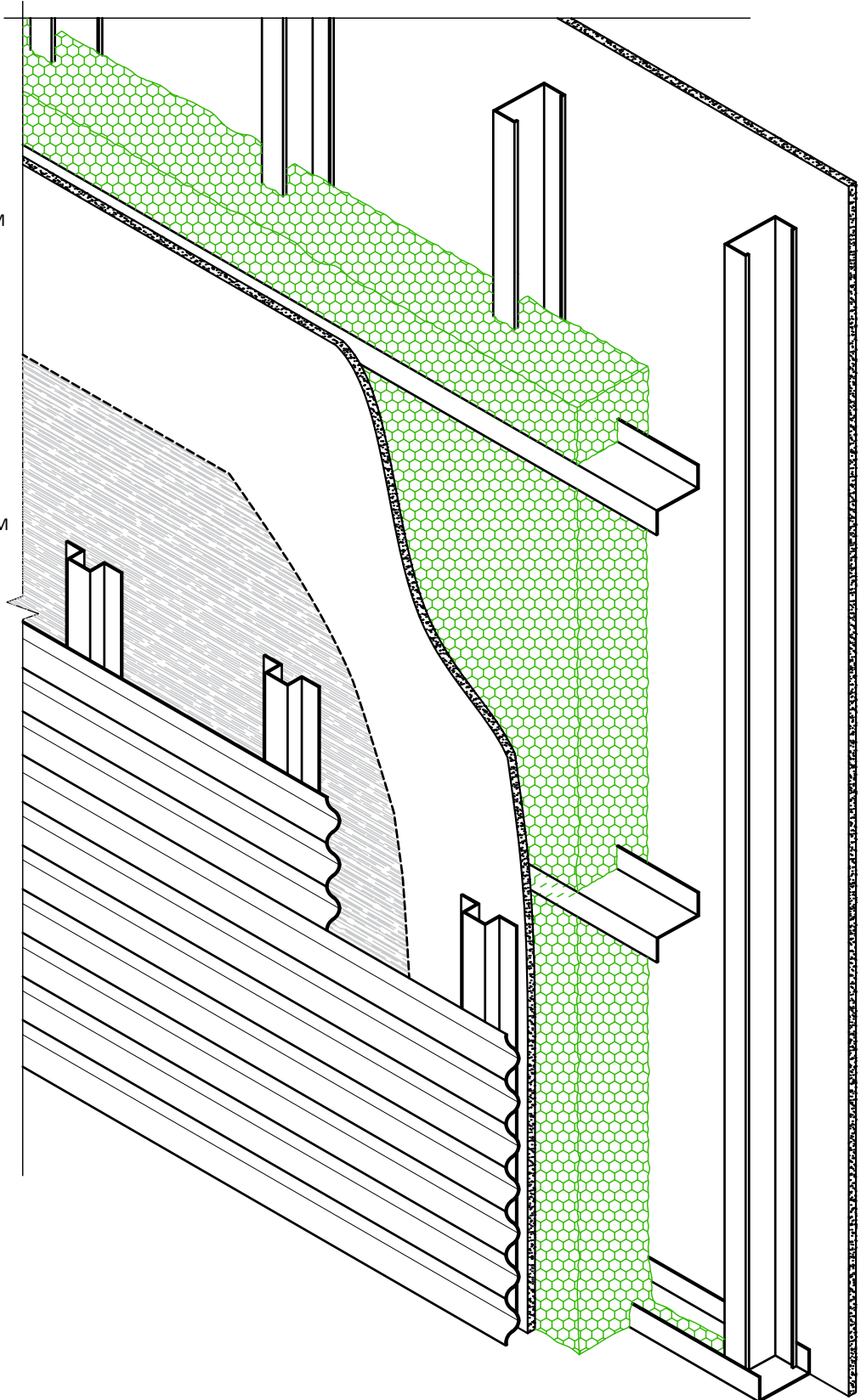

ISOMETRY SCENARIO 3-3.5  
LIGHTWEIGHT SIDING

Date:16-09-2021

Scale: Variable



## D-Max Wall Assembly – Acoustical Testing

AOITC (Apparent Outside Inside Transmission Class) : represents sound loss expressed in decibels (dB) depending on a source with a precise reference spectrum. This value corresponds to the difference between the sound pressure level emitted by a sound source on a facade of a building and a room inside it. Since no sound source is the same, the calculation is based on a source with virtual frequency behavior established in the E1332 standard and is done in accordance with ASTM E 966.

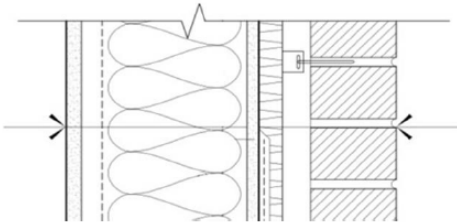
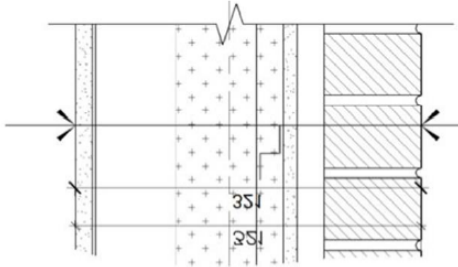
Test	Units	Cut	Assemblies	AOITC
#1 <u>Marc-Aurèle</u> (Mineral wool)	721	M-1		42
#2 <u>Saphir</u> (D-Max Wall)	GF Bathroom	M-2		45

**With an average difference of 3 dB, the M-2 composition can attenuate twice as much sound energy as the M-1 composition.**

# FWFO7.EW25 - Exterior Wall Systems Certified for Canada

## Exterior Wall Systems Certified for Canada

### System No. EW25

October 1, 2021

#### Exterior Wall Systems Certified for Canada

Tested in accordance with a fifteen minute fire exposure as per: National Building Code of Canada 2015, clause 3.2.3.8(1)(b), and National Building Code of Canada 2010, clause 3.2.3.8(1)(b)

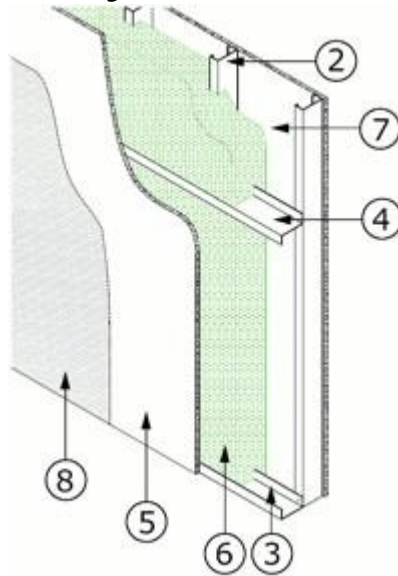

1. **Floor and Ceiling Tracks** — (not shown) 92 mm deep by 32 mm wide channel, 0.48 mm thick (26 gauge) galvanized steel, attached to masonry or concrete with fasteners spaced 610 mm OC.
2. **Steel Studs** — 92 mm deep by 38 mm wide channel, with 6 mm lip, 0.48 mm (26 gauge) thick galvanized steel, spaced 406 mm OC, fastened to the floor and ceiling tracks. Steel stud depth may vary depending on installed thickness of Item 6.
3. **C-channel** — 127 mm deep by 38 mm wide C-channel, 0.91 mm thick (20 gauge) galvanized steel, 3050 mm long, fastened to Item 2. C-channel located along the perimeter of the wall assembly. C-channel depth may be reduced depending on installed thickness of Item 6.
4. **Z-bar** — 127 mm deep by 38 mm wide Z-bar, 0.91 mm thick (20 gauge) galvanized steel, 3050 mm long, fastened to Item 2. Z-bar located at maximum 610 mm OC. Z-bar oriented horizontally. Z-bar depth may be reduced depending on installed thickness of Item 6. Z-bar must extend a minimum of 25 mm above the finished surface of Item 6.
5. **Gypsum Sheathing** — Minimum one layer of minimum 12.7 mm thick, UL Classified or ULC Listed, exterior gypsum sheathing, attached to steel studs and floor and ceiling track with Type S screws, 25 mm long, spaced 305 mm OC along edges of board in the field of the board.

**CERTAINTED GYPSUM INC** — GlasRoc

**GEORGIA-PACIFIC GYPSUM L L C** — Type DGG, DensGlass Gold Sheathing

**UNITED STATES GYPSUM CO** — USG SECUROCK® Sheathing

6. **Foamed Plastic** — Spray applied, foamed plastic insulation, maximum 32.7 kg/m<sup>3</sup>, to a maximum depth of 204 mm.

**HUNTSMAN BUILDING SOLUTIONS** — Airmetic Soya, Heatlok Soya, Polarfoam Soya, Airmetic Soya HFO, Heatlok Soya HFO, Polarfoam Soya HFO

7. **Gypsum Wallboard** — Minimum one layer of minimum 12.7 mm thick, UL Classified or ULC Listed, interior gypsum wallboard, attached to steel studs and floor and ceiling track with 3 mm diameter self-drilling screws, 25 mm long, spaced 305 mm OC along edges of board and in the field of the board.

8. **Weather Protection Membrane** — One layer of peel and stick vapor barrier, with 50 mm (maximum) overlap on all joints. Adhered with manufacturer's recommended primer at full coverage. Full surface or transitional.

Last Updated on 2021-10-01

---

The appearance of a company's name or product in this database does not in itself assure that products so identified have been manufactured under UL's Follow-Up Service. Only those products bearing the UL Mark should be considered to be Certified and covered under UL's Follow-Up Service. Always look for the Mark on the product.

UL permits the reproduction of the material contained in the Online Certification Directory subject to the following conditions: 1. The Guide Information, Assemblies, Constructions, Designs, Systems, and/or Certifications (files) must be presented in their entirety and in a non-misleading manner, without any manipulation of the data (or drawings). 2. The statement "Reprinted from the Online Certifications Directory with permission from UL" must appear adjacent to the extracted material. In addition, the reprinted material must include a copyright notice in the following format: "© 2021 UL LLC"

**ENGINEERING JUDGMENT FIRESTOP DETAIL**

PROJECT : D-MAX WALL  
 CONTRACTOR : HUNTSMAN BUILDING SOLUTIONS  
 F-RATING = 1-HR. OR 2-HR. (SEE NOTE NO. 2 BELOW)

**CROSS-SECTIONAL VIEW**

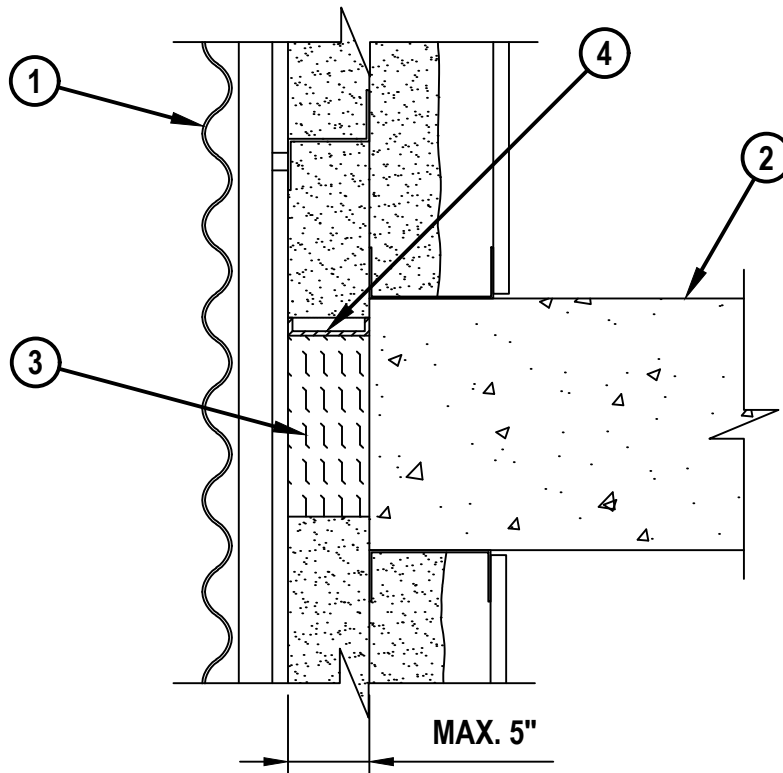

1. EXTERIOR DENSGLASS CURTAIN WALL ASSEMBLY WITH MAXIMUM 8" STEEL STUD FRAMING AND [OPTIONAL, NOT SHOWN] EIFS (NON FIRE-RATED).
2. CONCRETE FLOOR ASSEMBLY (MINIMUM 5" THICK) (1-HR. OR 2-HR. FIRE-RATING).
3. MINIMUM 4" THICKNESS MINERAL WOOL SAFING (MIN. 4 PCF DENSITY) COMPRESSED 33%. MINERAL WOOL MAY BE RECEESED BELOW TOP SURFACE OF FLOOR ASSEMBLY MAXIMUM 1".
4. MINIMUM 1/8" (WET) THICKNESS HILTI CFS-SP WB FIRESTOP JOINT SPRAY OR MINIMUM 2mm (WET) THICKNESS HILTI CFS-SP SIL FIRESTOP SILICONE JOINT SPRAY TO COMPLETELY COVER MINERAL WOOL, OVERLAPPING MINIMUM 1/2" ONTO ADJACENT ASSEMBLIES.

**NOTES :** 1. MAXIMUM WIDTH OF JOINT = 4".  
 2. FIRE-RATING OF ASSEMBLY IS DEPENDENT UPON THE PERFORMANCE OF CURTAIN WALL ASSEMBLY UNDER FIRE CONDITIONS.  
 3. THIS SYSTEM IS DESIGNED BASED UPON CANADIAN TEST STANDARD CAN/ULC-S115-2018 AND IN ACCORDANCE WITH ASTM E2307.

THIS ENGINEERING JUDGMENT REPRESENTS A FIRESTOP SYSTEM THAT WOULD BE EXPECTED TO PASS THE STATED RATINGS IF TESTED.  
 (REFERENCE : INTERTEK SYSTEM NO. HI/BP 120-04 & HI/BP 120-03)

 <b>Hilti Firestop Systems</b>	HILTI, Inc. Plano, Texas USA (800) 879-8000	Sheet 1 of 1	Drawing No.  <b>378451b</b>
	Designed by <i>Nathan Jennings</i>	Scale 3/16" = 1"	
		Date Mar. 29, 2021	
<b>Saving Lives through Innovation and Education</b>			

# ENGINEERING JUDGMENT FIRESTOP DETAIL

PROJECT : D-MAX WALL  
CONTRACTOR : HUNTSMAN BUILDING SOLUTIONS  
F-RATING = 1-HR. OR 2-HR. (SEE NOTE NO. 2 BELOW)

## CROSS-SECTIONAL VIEW

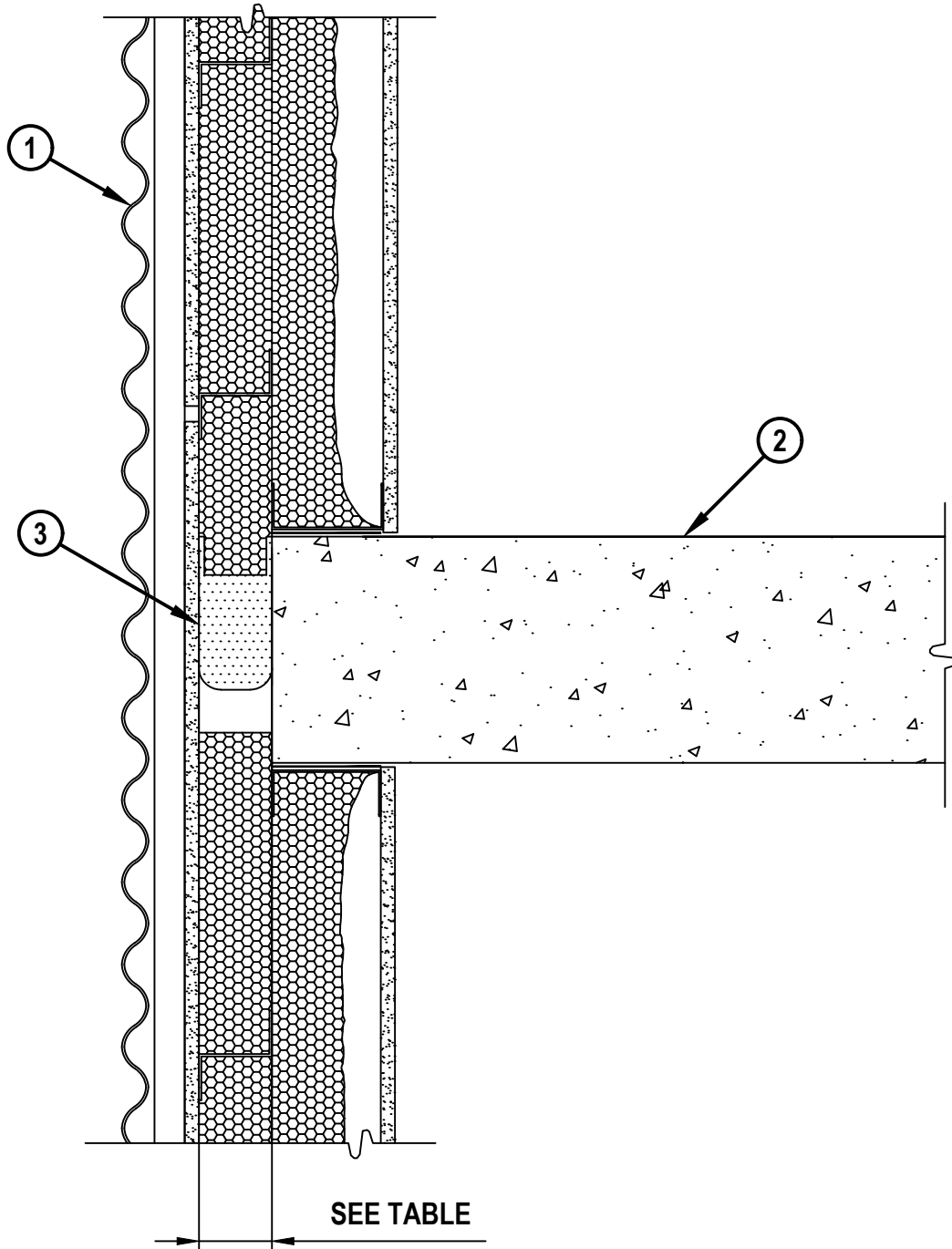

HILTI, Inc.  
Plano, Texas USA (800) 879-8000  
Designed by *Nathan Jennings*

Sheet	1 of 2
Scale	1/4" = 1"
Date	June 10, 2021

Drawing No.  
**524598a**

**ENGINEERING JUDGMENT FIRESTOP DETAIL**

PROJECT : D-MAX WALL  
 CONTRACTOR : HUNTSMAN BUILDING SOLUTIONS  
 F-RATING = 1-HR. OR 2-HR. (SEE NOTE NO. 2 BELOW)

1. EXTERIOR DENSGLASS CURTAIN WALL ASSEMBLY WITH MAXIMUM 8" STEEL STUD FRAMING AND [OPTIONAL] EIFS (NON FIRE-RATED).
2. CONCRETE FLOOR ASSEMBLY (MINIMUM 5" THICK) (1-HR. OR 2-HR. FIRE-RATING).
3. COMPRESS THE APPROPRIATELY SIZED EDGE OF SLAB QUICKSEAL (CFS-EOS QS) PRODUCT (PER TABLE BELOW) INTO PERIMETER JOINT. REMOVE PAPER FROM ADHESIVE AND ADHERE FLAPS FIRMLY TO ADJACENT SUBSTRATES. SPLICES (BUTT JOINTS) IN THE LENGTH OF EDGE OF SLAB QUICKSEAL (CFS-EOS QS) ARE TO BE TIGHTLY COMPRESSED TOGETHER (MINIMUM 1/4" COMPRESSION).

PRODUCT	ALLOWABLE JOINT WIDTH	
	MINIMUM	MAXIMUM
CFS-EOS QS SMALL	1-1/2"	3"
CFS-EOS QS MEDIUM	2"	4"
CFS-EOS QS LARGE	3"	5"

NOTES : 1. MAXIMUM WIDTH OF JOINT = 4".  
 2. FIRE-RATING OF ASSEMBLY IS DEPENDENT UPON THE PERFORMANCE OF CURTAIN WALL ASSEMBLY UNDER FIRE CONDITIONS.  
 3. THIS SYSTEM IS DESIGNED BASED UPON CANADIAN TEST STANDARD CAN/ULC-S115-2018 AND IN ACCORDANCE WITH ASTM E2307.

THIS ENGINEERING JUDGMENT REPRESENTS A FIRESTOP SYSTEM THAT WOULD BE EXPECTED TO PASS THE STATED RATINGS IF TESTED.  
 (REFERENCE : INTERTEK SYSTEM NO. HI/BP 120-04, HI/BP 120-03, HI/BPF 120-25 & HI/BPF 120-18)



Hilti Firestop Systems

HILTI, Inc.  
 Plano, Texas USA (800) 879-8000

Designed by

*Nathan Jennings*

Sheet 2 of 2

Scale -

Date June 10, 2021

Drawing No.

**524598a**

*Saving Lives through Innovation and Education*



# EDGE OF SLAB QUICKSEAL CFS-EOS QS

## Product description

- The industry’s first preformed solution for edge of slab and curtain wall firestopping, the new CFS-EOS QuickSeal represents Hilti’s leading innovation that is redefining the future of firestop safety.

## Applications for use

- Sealing building perimeter gaps between floor slabs and exterior curtain wall facades

## Advantages

- Easy, dry, and clean installation — no mineral wool fiber, spray or equipment required.
- Fast inspection — preformed firestop solutions may not require destructive testing
- Zero waste — controlled material cost / easy to bid
- Superior temperature ranges compared to traditional sprays and sealants
- Low VOC to meet owners sustainability requirements — LEED V4 and Living Building Challenge

## Installation instructions

- Use minimum 1” width metal roller for concrete floor and pre-cast concrete walls to ensure flap glue adhesion. See Hilti’s literature for third-party listings for complete application and installation for use.



## Technical Data

<b>Chemical basis</b>	Polyurethane foam
<b>Color</b>	Silver/ Red
<b>Recommended Application temperature</b>	23° to 122°F (-5° to 50°C)
<b>Storage and transportation temperature range</b>	14° to 122°F (-10° to 50°C)
<b>Temperature resistance range</b>	-31° to 140°F (-35° to 60°C)
<b>Movement</b>	Yes
<b>Mold and mildew performance</b>	Class 1 (ASTM G21-96)
<b>Tested in accordance with</b>	ASTM E2307, CAN/ULC S115, ASTM D6904 (rain resistance)
<b>LEEDv4.1 Compliant</b>	CDPH Standard Method v1.2-2017
<b>LEED VOC</b>	2 g/L
<b>Length</b>	60 in (5ft)
<b>Acoustics performance</b>	52 (relates to specific construction) ASTM E90
<b>Shelf Life</b>	24 months at 23°F - 122°F
<b>Joint Width</b>	1.5" - 5" (compatible with Hilti Spray for joints outside the allowable range)

## Specifications

- For the edge of slab conditions use pre-formed polyurethane foam based material for use as part of a perimeter fire barrier between fire resistance rated floors and exterior wall assemblies. Use tested systems HI/BPF 120-18 and 19, HI/BPF 120-20 and 21, HI/BPF 120-22 & 23, and HI/BPF 120-27 issued by Intertek Laboratories.

Order designation	Sales pack quantity	Item number
CFS-EOS QS Small (Joints 1.5" - 3")	28	2223950
CFS-EOS QS Medium (Joints 2" - 4")	21	2223951
CFS-EOS QS Large (Joints 3" - 5")	15	2223952



Instructions above are general guidelines – Always refer to 3rd party published listings or Hilti firestop system guide for complete installation information

## Optional Water Tightness:

- CFS-EOS WS Edge of Slab WaterStop (for QuickSeal only)



Order designation	Item number
CFS-EOS WS	2242385

## Specified Divisions

- DIV. 7: 07 84 43 Joint Firestopping
- DIV. 7: 07 84 53 Building Perimeter Firetopping
- DIV. 8: 08 44 00 Curtain Wall and Glazed Assemblies



# Fire Protection Products



ENGINEERING JUDGMENT FOR:
9/3/2020
Marc Simard
3M Canada Company

<b>Project:</b> Mur D-Max	<b>Contractor:</b> TBD
<b>Firestopping Category:</b> Joints / Perimeter	<b>Hourly Rating Requested / Type:</b> 1 and 2 Hour / F
<b>Joint Type:</b> Perimeter	<b>Obtainable Rating:</b> *see below
<b>Curtain Wall:</b> Exterior Grade Fiberglass Sheathed Gypsum Board	<b>Maximum Joint Width:</b> 4 Inch
<b>Type of Movement:</b> Dynamic	<b>Slab Assembly:</b> Concrete Floor

**Special Conditions:** Field conditions like Intertek Design 3MU/JS 120-22 with deviation of spray foam in lieu of the optional mineral wool batt curtain wall insulation. Steel studs terminate at top and bottom of concrete floor instead of passing through joint, and are tied to exterior wall with horizontal Z-shaped framing. Firestop may be recessed up 1 in. below top surface of concrete floor.

**Application Details:** To firestop this application, install in accordance with Intertek Design 3MU/JS 120-22 with the following modifications/clarifications:

1. Install min 4 in. depth of min 4 pcf mineral wool compressed min 33% within the joint. Mineral wool may be recessed below top surface of floor assembly maximum 1 in.
2. Install one of the following over the mineral wool:
  - Install a 1/10 in. wet thickness of Watertight Spray or 1/8 in. wet thickness of FireDam Spray 200 over the mineral wool.
    - o Watertight Spray or FireDam Spray 200 to overlap minimum ½ in. onto all surrounding substrates.
  - Install a minimum ¼ in. depth of sealant to completely cover the mineral wool. Sealant to be level with the top surface of the floor.
  - Install Fire and Water Barrier Tape to completely cover the mineral wool.
    - o Tape to overlap minimum 1 in. onto all surrounding substrates.
    - o Splices in the tape system to overlap minimum ½ in.
3. \*The obtainable rating in this scenario is reduced to “Up to 1- or 2-hour F only or as long as the entire assembly remains fully intact in a fire scenario”.

**3M Fire Barrier Material:** FireDam Spray 200, FB 1003SL Silicone Sealant, Fire and Water Barrier Tape, 3M Fire Barrier Watertight Spray

**Based On:** 3MU/JS 120-22  
**Additional Referenced System(s):** (See Attached Drawing)

This Engineering Judgment (EJ) is based upon the sole and exclusive use of 3M brand Fire Protection Products as described within. Modification of any of the parameters of this EJ, including, without limitation, the use of non-3M brand Fire Protection Products, shall render this EJ null and void. This perimeter fire barrier design is expected to achieve the hourly rating indicated above. This engineering judgment is based on performance results obtained in testing with independent laboratories which have been tested in accordance to ASTM E 2307 and / or internal 3M fire tests, and CAN/ULC-S115.

Engineering Judgment Prepared By:



Paul Fannin  
Senior Application Engineer

Reviewed By:



610333  
cc: Bethany Turowec  
Email: bturowec@mmm.com

**Technical Information, Product Selection and Use**

The technical information, guidance and other statements contained in this document are based upon records, tests or experience that 3M believes are reliable, but the accuracy or completeness of such information is not guaranteed and may not be indicative of field conditions. Many factors beyond 3M's control and uniquely within user's knowledge and control can affect the use and performance of a 3M product in a particular application. As a result, customer is solely responsible for evaluating the 3M product and determining whether it is appropriate and suitable for customer's application. 3M product purchases are subject to the terms, conditions and limitations set forth in the applicable Technical Data Sheet

3M FIRE PROTECT

3M ENGINEERING JUDGEMENT NO. 610333  
 MODIFIED SYSTEM NO. 3MU/JS 120-22  
 REQUESTED F RATING - 1 & 2 HR  
 OBTAINABLE RATING: \*SEE BELOW

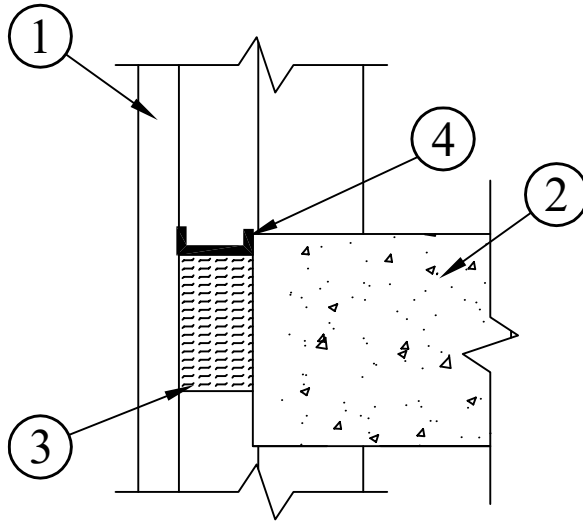

- 1. EXTERIOR GRADE FIBERGLASS SHEATHED GYPSUM BOARD..
- 2. CONCRETE FLOOR.
- 3. 4 PCF MINERAL WOOL.
- 4. FIRESTOP SEALANT/SPRAY AS OUTLINED IN APPROPRIATE VERSION OF CORRESPONDING EJ. (SPRAY DEPICTED)

\*THE OBTAINABLE RATING IN THIS SCENARIO IS REDUCED TO "UP TO 1- OR 2-HOUR F ONLY OR AS LONG AS THE ENTIRE ASSEMBLY REMAINS FULLY INTACT IN A FIRE SCENARIO".

SEE APPLICATION DETAIL NOTES ON APPROPRIATE VERSION OF CORRESPONDING EJ.

CONFIGURATION OR ORIENTATION OF PENETRANT(S)/OPENING(S) MAY NOT MATCH SITE CONDITION(S).

CONSULT CURRENT INDEPENDENT TESTING LABORATORIES (UL/INTERTEK) FOR SYSTEMS OR DESIGN DETAILS

PROJECT:  
**MUR D-MAX**

SIGNATURE:  
*Bruce Fitzwater*

REV:	DATE:	DESCRIPTION	DRWN BY:
0	09-03-20	ORIGINAL ISSUE	BLF

THIS ELEMENTARY FIRESTOP DRAWING IS TO BE USED ALONG WITH THE CORRESPONDING ENGINEERING JUDGMENT AND REFERENCED LISTED/TESTED SYSTEMS FROM INDEPENDENT TESTING LABORATORIES (UL/INTERTEK). DRAWING NOT TO SCALE.

DWG. LOCATION: <b>610333.DWG</b>	DATE: <b>09-03-20</b>
-------------------------------------	--------------------------

ALL STATEMENTS, TECHNICAL INFORMATION AND RECOMMENDATIONS CONTAINED HEREIN ARE BASED ON TEST: WE BELIEVE TO BE RELIABLE, HOWEVER, SINCE THE CONDITIO OF USE AND APPLICATION ARE BEYOND OUR CONTROL, 3M SHALL NOT BE LIABLE FOR ANY DAMAGE, DIRECT OR CONSEQUENTIAL, RESULTING FROM THE USE OF THIS MATERI/ OR DESIGN. 3M'S ONLY WARRANTY SHALL BE TO REPLACE AN/ OF OUR PRODUCTS PROVED TO BE DEFECTIVE.

**3M** Fire Protection Products

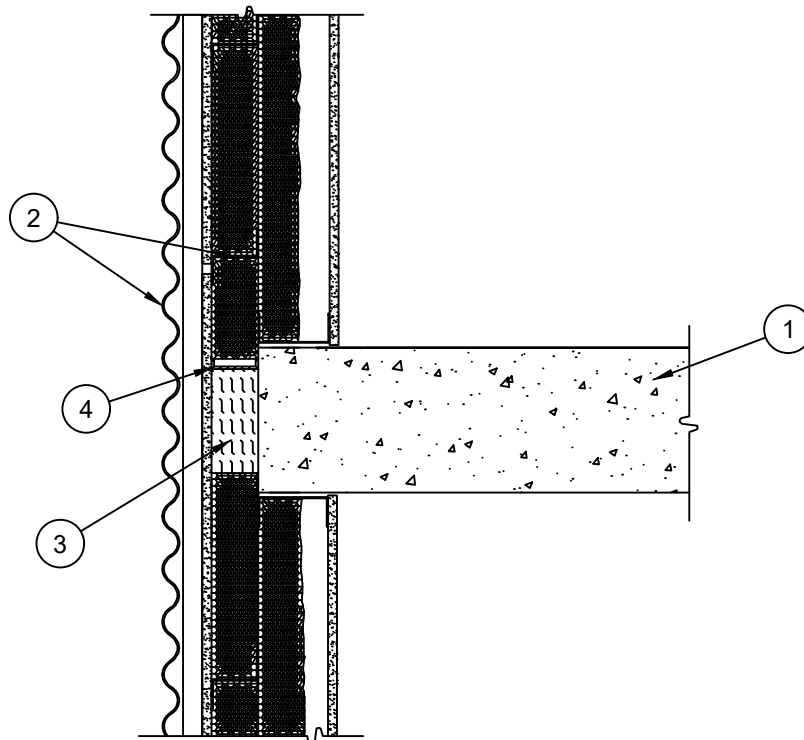

1. **Floor Assembly (2 Hr)** - Min 5" thick concrete floor assembly.
2. **Curtain Wall Assembly (Non Fire Rated)** - Exterior densglass curtain wall assembly with max 8" steel stud framing. Max width of joint is 4".
3. **Packing Material** - Min 4 pcf density mineral wool batt insulation compressed a min 33% and installed within joint to a min 4" depth, flush with top surface of floor. When sealant is used, recess to accommodate for the required depth of sealant.
4. **Spray** - SpecSeal® AS200, Fast Tack, or SFS Safing Spray applied to completely cover mineral wool to a min 1/8" wet thickness, overlapping onto surrounding substrates a min 1/2".
5. **Sealant (Optional)** - In lieu of spray, SpecSeal® SIL300SL Sealant applied within joint to a min 1/2" depth. Sealant to be flush with top surface of floor.

**\*Notes: 1** - Rating of the firestop system is dependent on the performance of the surrounding construction under fire exposure with a max possible F rating of 2 Hr.

THIS DESIGN REPRESENTS A FIRESTOP SYSTEM EXPECTED TO PASS THE STATED RATINGS IF TESTED

Project: Huntsman Building Solutions		Signature: 		System Reference: CW-D-1011	
Project Address:		Date: 3/31/2021		PAGE 1 OF 1	
Designed by: Joe Potts					
Contractor/Architect: Hunstman Building Services		Scale: N.T.S.		Based on testing to ASTM E2307 and CAN/ULC-S115 Standard Test Method of Fire Tests of Through-Penetration and Joint Firestops	



**Specified Technologies Inc.**

210 Evans Way • Somerville, NJ 08876 USA • Toll Free: 800-992-1130 • T: +1 908-526-8000  
F: +1 908-231-8415 • E: techserv@stfirestop.com • www.stfirestop.com

All statements, technical information, and recommendations contained herein are based upon tests we believe to be accurate; however since the conditions of use and application are beyond our control, STI shall not be liable for any damage, direct or consequential, resulting from the use of this material or design. STI's sole warranty shall be to refund or replace materials found to be defective.