

REACTOR™

312067D

Electric, Heated, Plural Component Proportioner
For spraying polyurethane foam and polyurea coatings.
Not for use in explosive atmospheres.



Important Safety Instructions

Read all warnings and instructions in this manual and in manuals 312065 and 312066. Save all instruction manuals.

See page 3 for model information, including maximum working pressure and approvals.

Model E-XP1 Shown

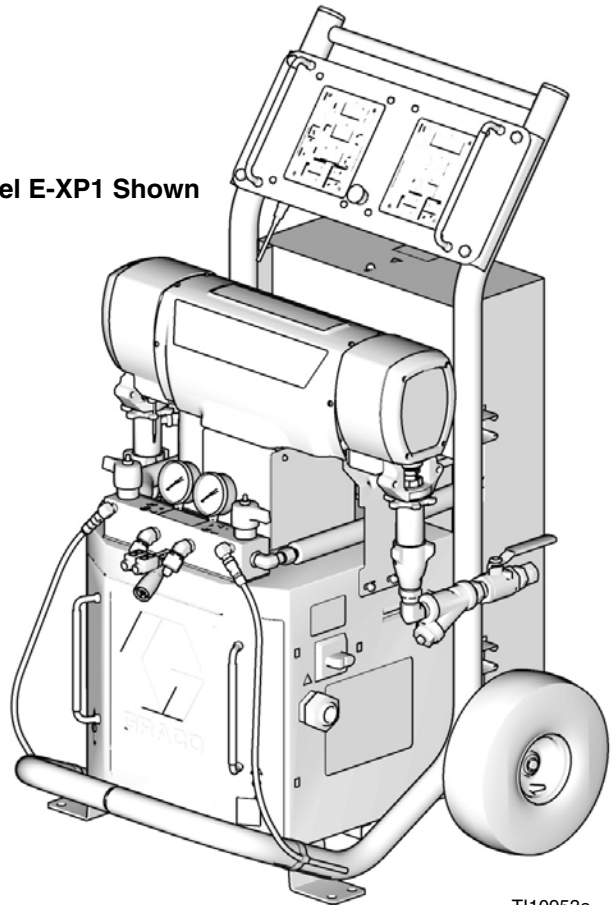

TI10953a

CE



9902471
Conforms to ANSI/UL
Std. 499 Certified to
CAN/CSA Std.
C22.2 No. 88

Contents

| | | | |
|--|----------|--|-----------|
| Supplied Manuals | 2 | Detailed Schematic, Motor Controls | 8 |
| Models | 3 | E-20 and E-XP1 Series | 8 |
| Simplified Schematics, Motor Controls | 4 | E-30 and E-XP2 Series | 9 |
| E-20 and E-XP1 Series | 4 | Detailed Schematic, Heater Controls | 10 |
| E-30 and E-XP2 Series | 5 | Graco Standard Warranty | 12 |
| Simplified Schematic, Heater Controls | 6 | Graco Information | 12 |
| Simplified Schematic, Power Connections | 7 | | |

Supplied Manuals

The following manuals are shipped with the Reactor™ Proportioner. Refer to these manuals for detailed equipment information.

Order Part 15M334 for a compact disk of Reactor manuals translated in several languages.

Manuals are also available at www.graco.com.

| Reactor Electric Proportioner - Operation | |
|---|--|
| Part | Description |
| 312065 | Reactor Electric Proportioner, Operation Manual (English) |
| Reactor Electric Proportioner - Repair/Parts | |
| Part | Description |
| 312066 | Reactor Electric Proportioner, Repair-Parts Manual (English) |
| Proportioning Pump | |
| Part | Description |
| 309577 | Electric Reactor Displacement Pump Repair-Parts Manual (English) |

Models

E-20 SERIES

| Part, Series | Full Load Peak Amps* | Voltage (phase) | System Watts† | Primary Heater Watts | Max Flow Rate◆ lb/min (kg/min) | Approximate Output per Cycle (A+B) gal. (liter) | Maximum Fluid Working Pressure psi (MPa, bar) |
|--------------|----------------------|-----------------|---------------|----------------------|-----------------------------------|--|--|
| 259025, E | 48 | 230V (1) | 10,200 | 6,000 | 20 (9) | 0.0104 (0.0395) | 2000 (14, 140) |
| 259030, E | 24 | 400V (3) | 10,200 | 6,000 | 20 (9) | 0.0104 (0.0395) | 2000 (14, 140) |
| 259034, E | 32 | 230V (3) | 10,200 | 6,000 | 20 (9) | 0.0104 (0.0395) | 2000 (14, 140) |

E-30 SERIES

| Part, Series | Full Load Peak Amps* | Voltage (phase) | System Watts† | Primary Heater Watts | Max Flow Rate◆ lb/min (kg/min) | Approximate Output per Cycle (A+B) gal. (liter) | Maximum Fluid Working Pressure psi (MPa, bar) |
|--------------|----------------------|-----------------|---------------|----------------------|-----------------------------------|--|--|
| 259026, E | 78 | 230V (1) | 17,900 | 10,200 | 30 (13.5) | 0.0272 (0.1034) | 2000 (14, 140) |
| 259031, E | 34 | 400V (3) | 17,900 | 10,200 | 30 (13.5) | 0.0272 (0.1034) | 2000 (14, 140) |
| 259035, E | 50 | 230V (3) | 17,900 | 10,200 | 30 (13.5) | 0.0272 (0.1034) | 2000 (14, 140) |
| 259057, E | 100 | 230V (1) | 23,000 | 15,300 | 30 (13.5) | 0.0272 (0.1034) | 2000 (14, 140) |
| 259058, E | 62 | 230V (3) | 23,000 | 15,300 | 30 (13.5) | 0.0272 (0.1034) | 2000 (14, 140) |
| 259059, E | 35 | 400V (3) | 23,000 | 15,300 | 30 (13.5) | 0.0272 (0.1034) | 2000 (14, 140) |

E-XP1 SERIES

| Part, Series | Full Load Peak Amps* | Voltage (phase) | System Watts† | Primary Heater Watts | Max Flow Rate◆ gpm (lpm) | Approximate Output per Cycle (A+B) gal. (liter) | Maximum Fluid Working Pressure psi (MPa, bar) |
|--------------|----------------------|-----------------|---------------|----------------------|-----------------------------|--|--|
| 259024, E | 69 | 230V (1) | 15,800 | 10,200 | 1.0 (3.8) | 0.0104 (0.0395) | 2500 (17.2, 172) |
| 259029, E | 24 | 400V (3) | 15,800 | 10,200 | 1.0 (3.8) | 0.0104 (0.0395) | 2500 (17.2, 172) |
| 259033, E | 43 | 230V (3) | 15,800 | 10,200 | 1.0 (3.8) | 0.0104 (0.0395) | 2500 (17.2, 172) |

E-XP2 SERIES

| Part, Series | Full Load Peak Amps* | Voltage (phase) | System Watts† | Primary Heater Watts | Max Flow Rate◆ gpm (lpm) | Approximate Output per Cycle (A+B) gal. (liter) | Maximum Fluid Working Pressure psi (MPa, bar) |
|--------------|----------------------|-----------------|---------------|----------------------|-----------------------------|--|--|
| 259028, E | 100 | 230V (1) | 23,000 | 15,300 | 2.0 (7.6) | 0.0203 (0.0771) | 3500 (24.1, 241) |
| 259032, E | 35 | 400V (3) | 23,000 | 15,300 | 2.0 (7.6) | 0.0203 (0.0771) | 3500 (24.1, 241) |
| 259036, E | 62 | 230V (3) | 23,000 | 15,300 | 2.0 (7.6) | 0.0203 (0.0771) | 3500 (24.1, 241) |

* Full load amps with all devices operating at maximum capabilities. Fuse requirements at various flow rates and mix chamber sizes may be less.

† Total system watts, based on maximum hose length for each unit:

- E-20 and E-XP1 series, 210 ft (64 m) maximum heated hose length, including whip hose.
- E-30 and E-XP2 series, 310 ft (94.5 m) maximum heated hose length, including whip hose.

◆ Maximum flow rate given for 60 Hz operation. For 50 Hz operation, maximum flow rate is 5/6 of 60 Hz maximum flow.

Simplified Schematics, Motor Controls

E-20 and E-XP1 Series

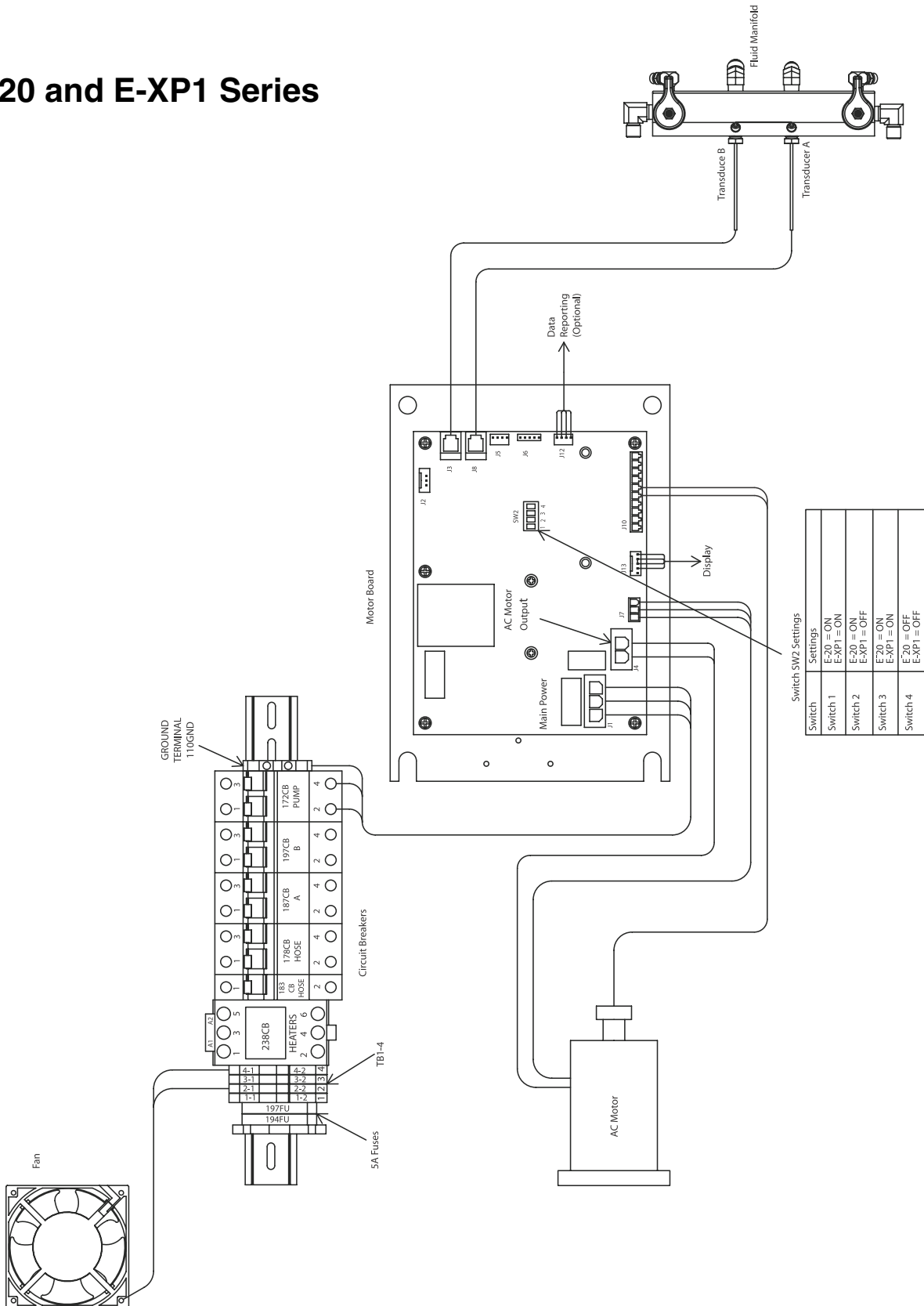

Simplified Schematics, Motor Controls (cont.)

E-30 and E-XP2 Series

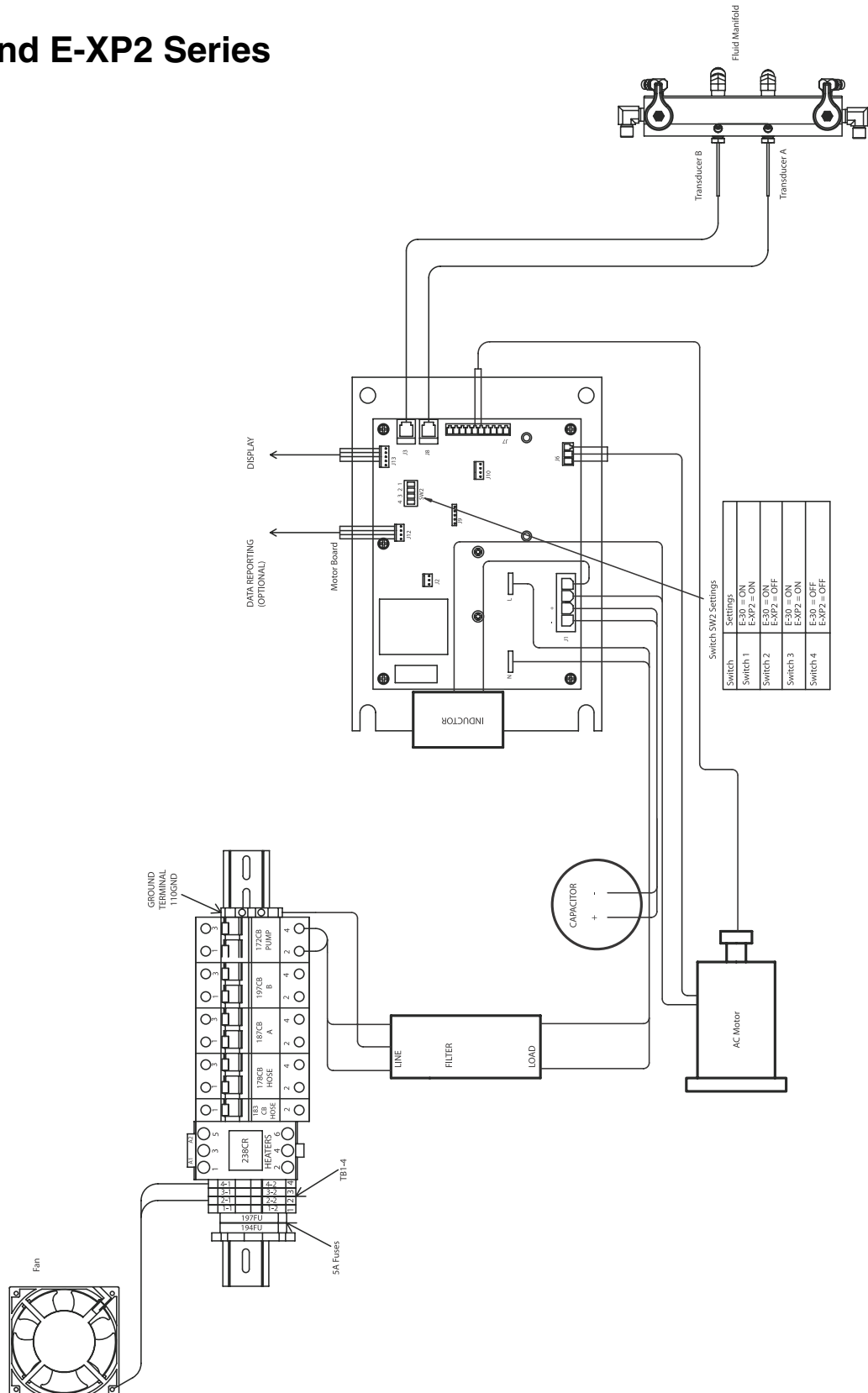

Simplified Schematic, Heater Controls

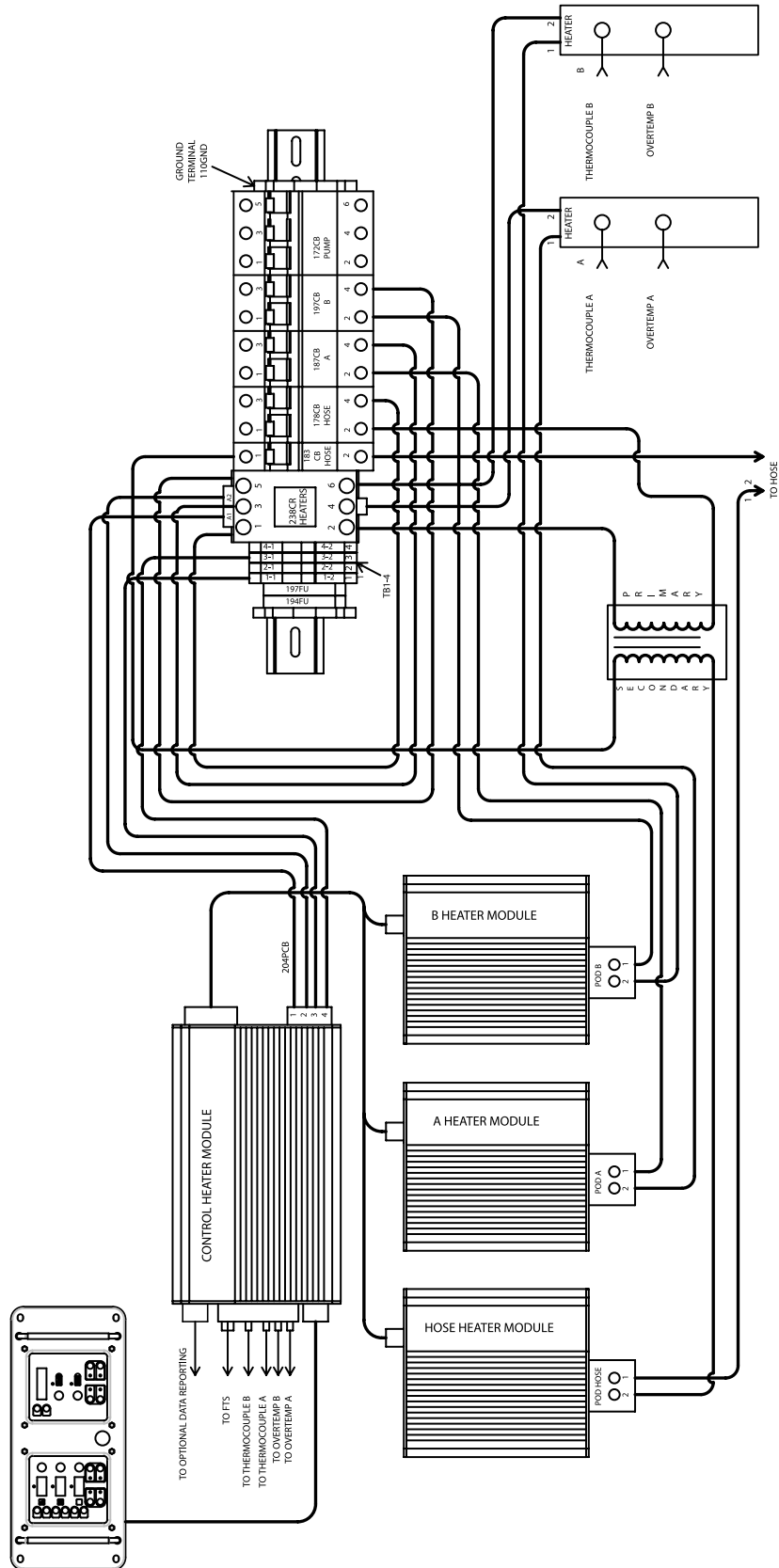

Simplified Schematic, Power Connections

230Vac, 1 Phase

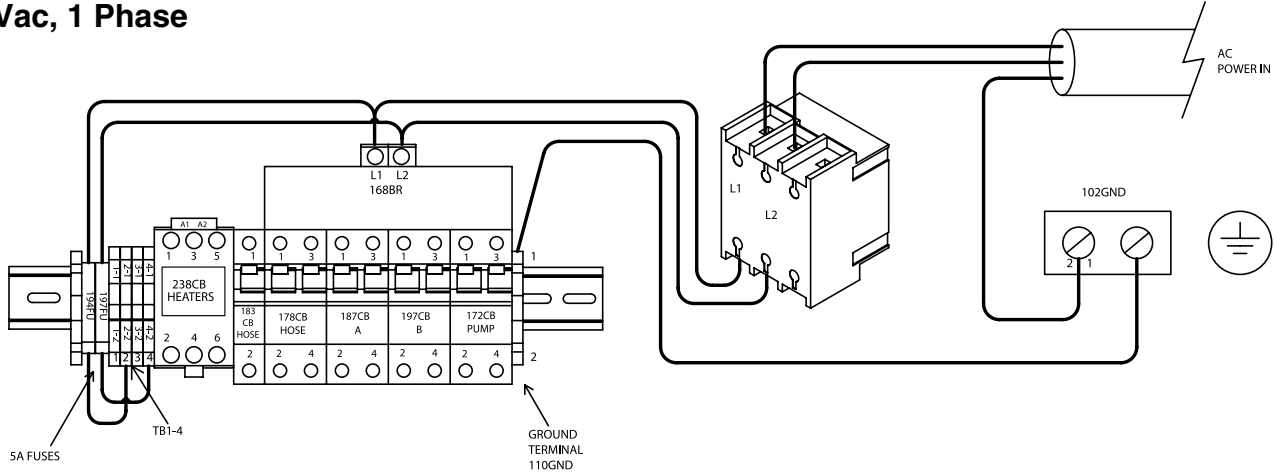

230Vac, 3 Phase

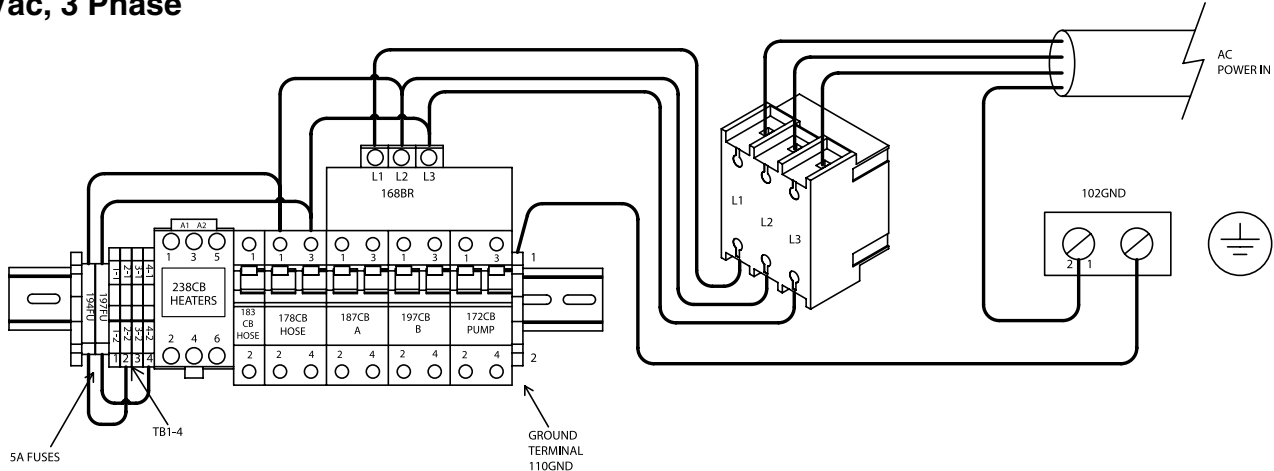

400Vac, 3 Phase

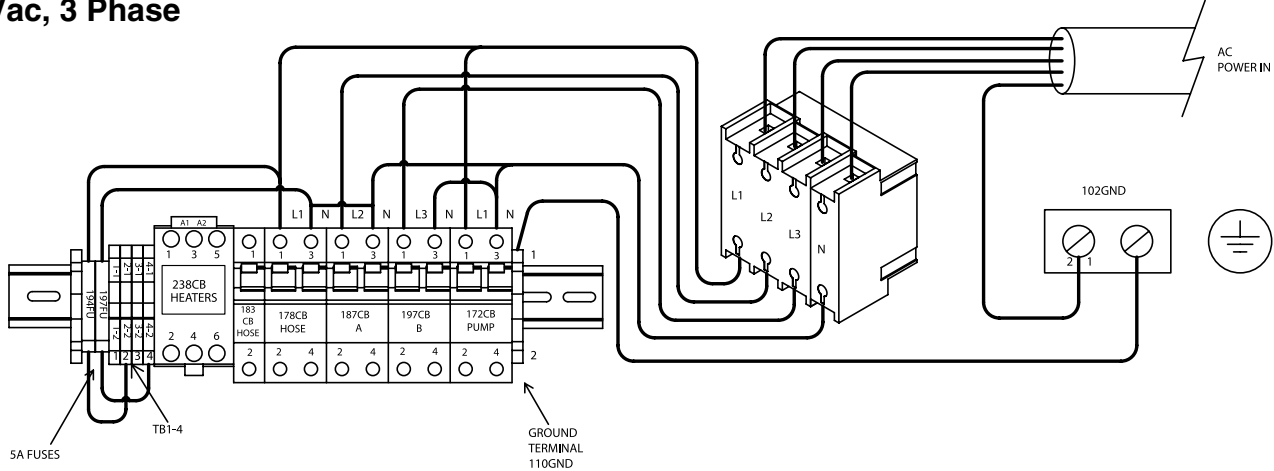

Detailed Schematic, Motor Controls

E-20 and E-XP1 Series

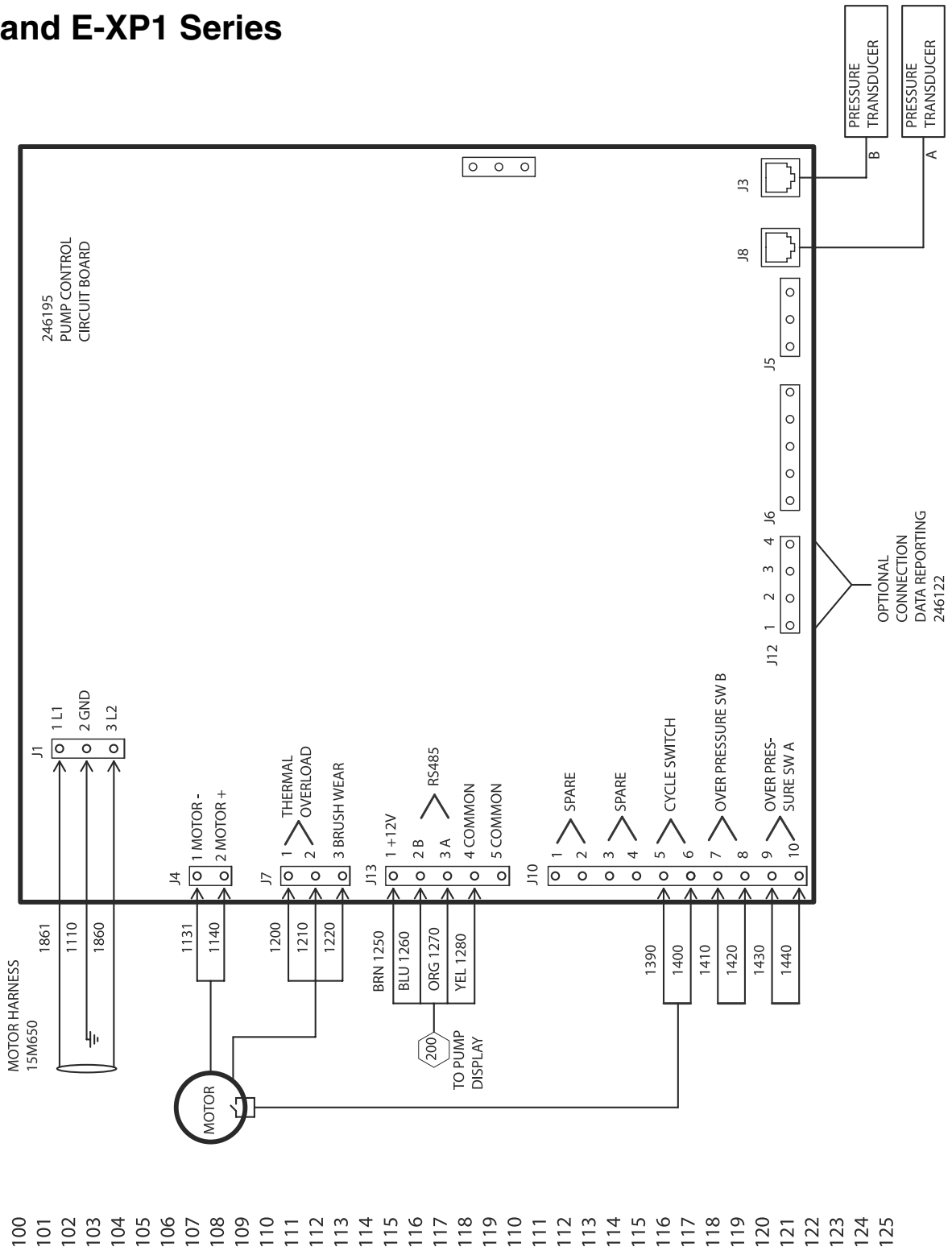

Detailed Schematic, Motor Controls (cont.)

E-30 and E-XP2 Series

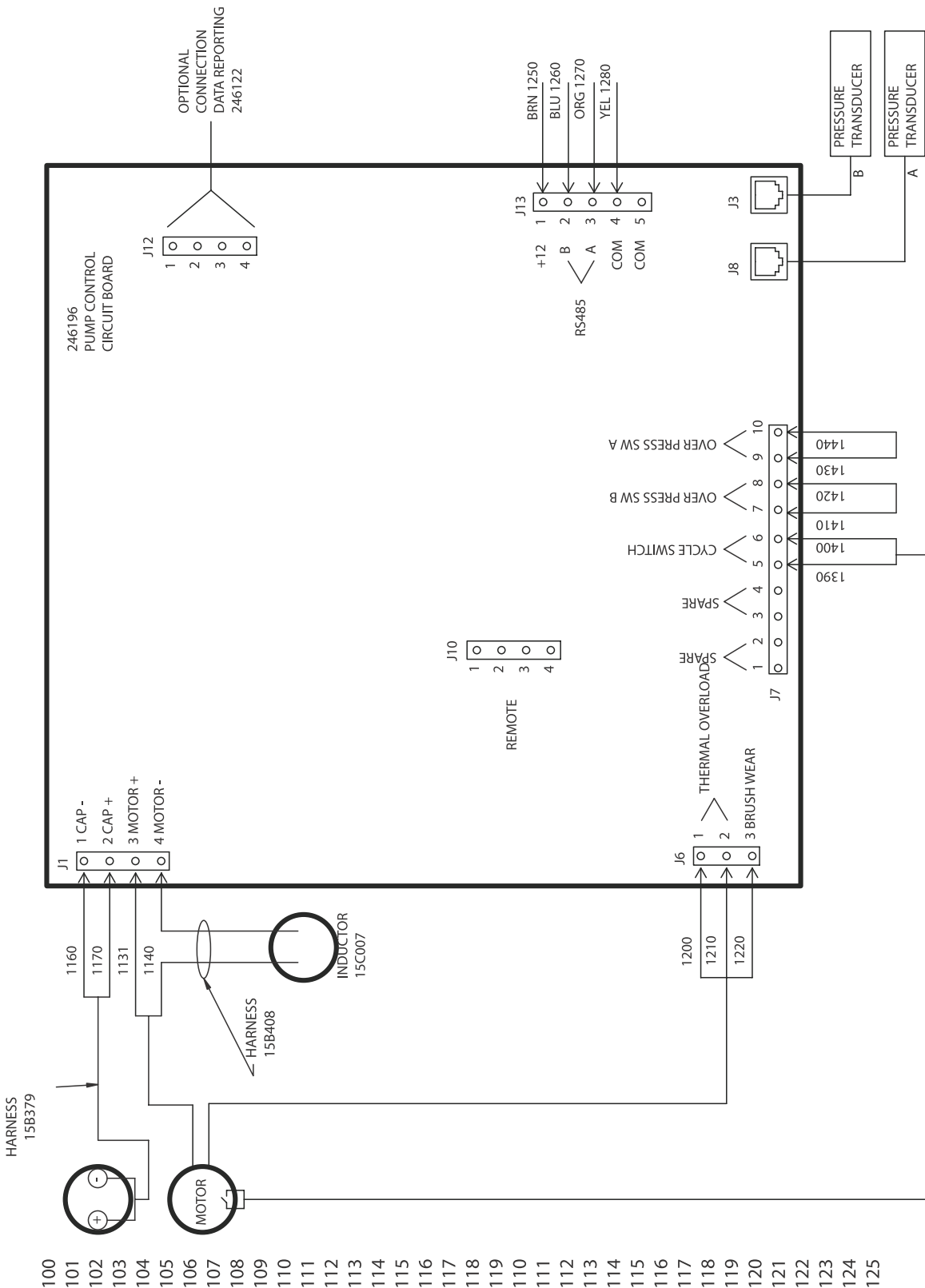

Detailed Schematic, Heater Controls

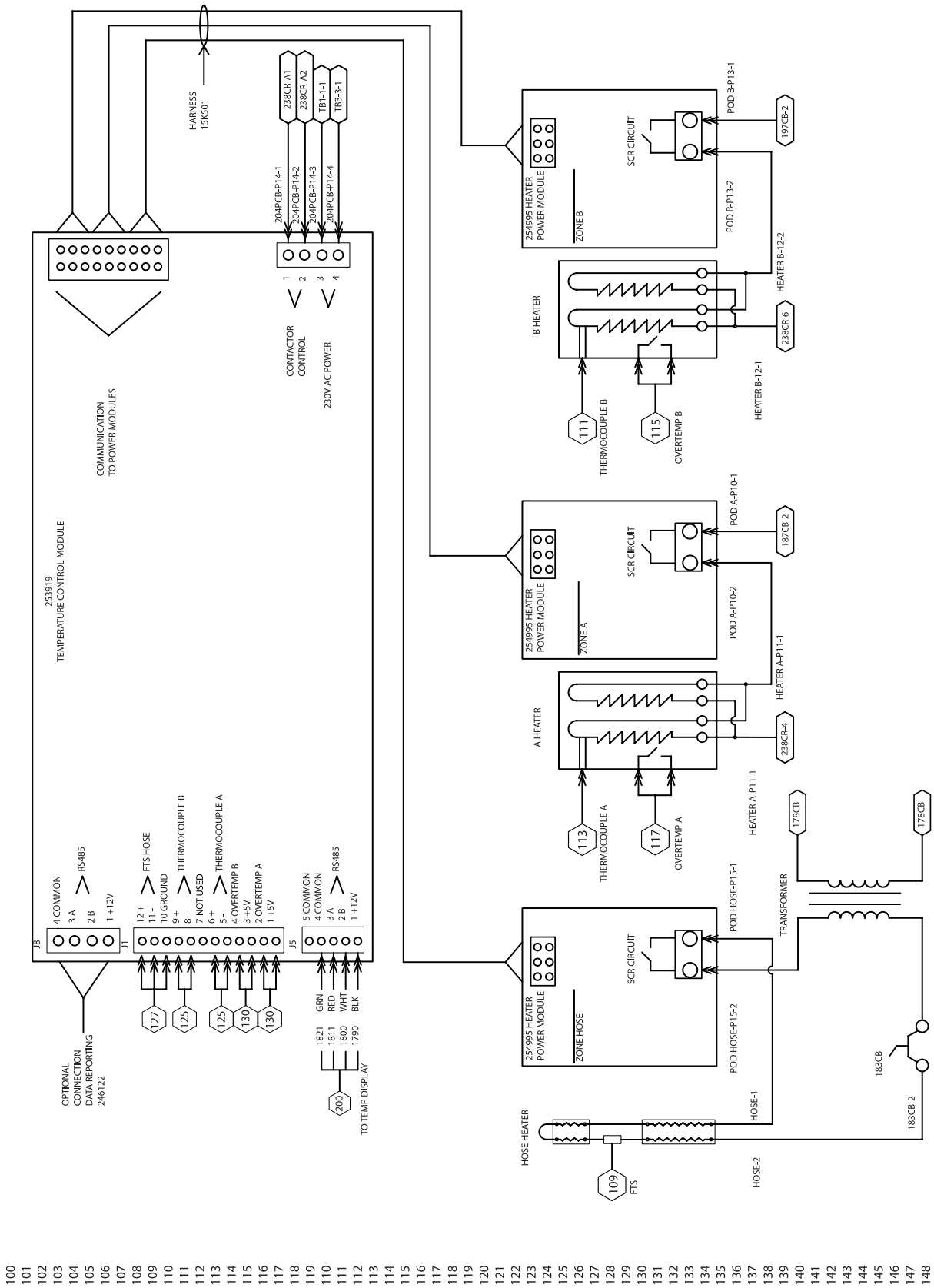

- 100
- 101
- 102
- 103
- 104
- 105
- 106
- 107
- 108
- 109
- 110
- 111
- 112
- 113
- 114
- 115
- 116
- 117
- 118
- 119
- 120
- 121
- 122
- 123
- 124
- 125
- 126
- 127
- 128
- 129
- 130
- 131
- 132
- 133
- 134
- 135
- 136
- 137
- 138
- 139
- 140
- 141
- 142
- 143
- 144
- 145
- 146
- 147
- 148

Graco Standard Warranty

Graco warrants all equipment referenced in this document which is manufactured by Graco and bearing its name to be free from defects in material and workmanship on the date of sale to the original purchaser for use. With the exception of any special, extended, or limited warranty published by Graco, Graco will, for a period of twelve months from the date of sale, repair or replace any part of the equipment determined by Graco to be defective. This warranty applies only when the equipment is installed, operated and maintained in accordance with Graco's written recommendations.

This warranty does not cover, and Graco shall not be liable for general wear and tear, or any malfunction, damage or wear caused by faulty installation, misapplication, abrasion, corrosion, inadequate or improper maintenance, negligence, accident, tampering, or substitution of non-Graco component parts. Nor shall Graco be liable for malfunction, damage or wear caused by the incompatibility of Graco equipment with structures, accessories, equipment or materials not supplied by Graco, or the improper design, manufacture, installation, operation or maintenance of structures, accessories, equipment or materials not supplied by Graco.

This warranty is conditioned upon the prepaid return of the equipment claimed to be defective to an authorized Graco distributor for verification of the claimed defect. If the claimed defect is verified, Graco will repair or replace free of charge any defective parts. The equipment will be returned to the original purchaser transportation prepaid. If inspection of the equipment does not disclose any defect in material or workmanship, repairs will be made at a reasonable charge, which charges may include the costs of parts, labor, and transportation.

THIS WARRANTY IS EXCLUSIVE, AND IS IN LIEU OF ANY OTHER WARRANTIES, EXPRESS OR IMPLIED, INCLUDING BUT NOT LIMITED TO WARRANTY OF MERCHANTABILITY OR WARRANTY OF FITNESS FOR A PARTICULAR PURPOSE.

Graco's sole obligation and buyer's sole remedy for any breach of warranty shall be as set forth above. The buyer agrees that no other remedy (including, but not limited to, incidental or consequential damages for lost profits, lost sales, injury to person or property, or any other incidental or consequential loss) shall be available. Any action for breach of warranty must be brought within two (2) years of the date of sale.

GRACO MAKES NO WARRANTY, AND DISCLAIMS ALL IMPLIED WARRANTIES OF MERCHANTABILITY AND FITNESS FOR A PARTICULAR PURPOSE, IN CONNECTION WITH ACCESSORIES, EQUIPMENT, MATERIALS OR COMPONENTS SOLD BUT NOT MANUFACTURED BY GRACO. These items sold, but not manufactured by Graco (such as electric motors, switches, hose, etc.), are subject to the warranty, if any, of their manufacturer. Graco will provide purchaser with reasonable assistance in making any claim for breach of these warranties.

In no event will Graco be liable for indirect, incidental, special or consequential damages resulting from Graco supplying equipment hereunder, or the furnishing, performance, or use of any products or other goods sold hereto, whether due to a breach of contract, breach of warranty, the negligence of Graco, or otherwise.

FOR GRACO CANADA CUSTOMERS

The Parties acknowledge that they have required that the present document, as well as all documents, notices and legal proceedings entered into, given or instituted pursuant hereto or relating directly or indirectly hereto, be drawn up in English. Les parties reconnaissent avoir convenu que la rédaction du présente document sera en Anglais, ainsi que tous documents, avis et procédures judiciaires exécutés, donnés ou intentés, à la suite de ou en rapport, directement ou indirectement, avec les procédures concernées.

Graco Information

For the latest information about Graco products, visit www.graco.com.

TO PLACE AN ORDER, contact your Graco distributor or call to identify the nearest distributor.

Phone: 612-623-6921 **or Toll Free:** 1-800-328-0211 **Fax:** 612-378-3505

*All written and visual data contained in this document reflects the latest product information available at the time of publication.
Graco reserves the right to make changes at any time without notice.*

This manual contains English. MM 312067

Graco Headquarters: Minneapolis

International Offices: Belgium, China, Japan, Korea

GRACO INC. P.O. BOX 1441 MINNEAPOLIS, MN 55440-1441

Copyright 2007, Graco Inc. is registered to ISO 9001

www.graco.com

Revised 07/2009