

HUNTSMAN

SOLUTIONS BÂTIMENTS

02.02.2022

Mur D-Max

Avantages par rapport à l'isolation extérieure

- Giclage peu importe la température ou le vent (jusqu'à -20°C)
- Aucun échafaudage ou nacelle. Moins de machinerie donc moins de coût de location, de logistique et de risque d'accident.
- L'isolation du bâtiment est possible au fur et à mesure que les murs montent.
- Moins de matériaux donc économie de coût et de temps en exécution.
- Économie importante sur le chauffage en hiver.
- Évite la compartimentation extérieure (Article 3.1.11.2. de CNB ou CCQ).
- Assemblage testé CAN/ULC S101 pour bâtiments de grande hauteur (>3 étages). (UL EW25)
- Séquence de travaux plus simple et plus facile à gérer pour le surintendant car il y a moins d'intervenants et de travailleurs pour exécuter chaque étape.
- Évite l'overspray.
- Évite la pose d'une fourrure intérieure comparativement avec une cavité de laine car l'électricité peut passer dans l'espace des colombages.

Assemblage :

- Revêtement léger ou brique
- Barres omega ou attaches à brique
- Panneau extérieur avec joints membranés (Densglass Gold, Securock, Glasroc)
- Airmétic Soya HFO R-6/pouce (épaisseur variable)
- Barres Z (épaisseur variable)
- Colombage métallique 6" ou 3 5/8"
- Gypse intérieur

LISTE PARTIELLE DE PROJETS D-MAX

PROJET
COMPLÉTÉ
Le Saint-Philippe
Bâtiment K
Le Nicolas
Saphir
Liénard
Le Guillaume
Archipel
Huma 2
EN CONSTRUCTION ET À VENIR
Circa Condo
800 Charest
Lokia
Réseau Sélection Mirabel
Viridi
Novit
Père Le Lièvre
Sir John
Maison de femmes autochtones
Satori
Lab École-Gatineau
Ilot St-Charles
District Concorde (3 tours)
Mgr Plessis
Capella
Newman RPA Ph2
Maestria tour 1 (alcove)
Maestria tour 2 (alcove)
Maison Benoit Labre
Concordia
Symposium
Medway (800 route des rivières)
Place Frontenac
PROJETS ALTERNATIFS D-MAX
Château Bellevue 2
Les Loges 6
Le Fleurimont
Huma 1

870 Curé Boivin, Boisbriand, Quebec, Canada J7G 2A7
 Tel: 450.437.0123 866.437.0223
www.huntsmanbuildingsolutions.com

A business unit of Huntsman Corporation



Projet Nicolas



Projet Bâtiment K – Faubourg du Moulin



Projet Saint-Philippe







MUR D-MAX

AVANT LE DÉBUT DE LA CONSTRUCTION DE L'ASSEMBLAGE DE MUR, UNE RÉUNION DE DÉMARRAGE EST FORTEMENT RECOMMANDÉE AVEC LES DIFFÉRENTS PROFESSIONNELS POUR COORDONNER LES ÉTAPES ET DÉTAILS DE CONSTRUCTION. NOUS SOMMES DISPONIBLES POUR CETTE RÉUNION.

- 1) L'AVANTAGE DE CETTE COUPE DE MUR EST UNE VALEUR R EFFECTIVE MAXIMUM DANS UN MUR TRÈS MINCE. CECI AUGMENTE LA SURFACE DE PLANCHER HABITABLE. LE COLOMBAGE PEUT ÊTRE UN 92 MM OU UN 152MM SELON LE CHOIX DU CONCEPTEUR.
- 2) CETTE COUPE DE MUR PERMET DE TRAVAILLER TOUTE L'ISOLATION DE L'INTÉRIEUR À L'ABRI DES INTEMPÉRIES ET SANS ÉCHAFAUDAGE.
- 3) L'ÉPAISSEUR DE LA BARRE Z EXTÉRIEURE EST VARIABLE DE 25 À 125MM SELON LA VALEUR R EFFECTIVE DÉSIRÉE ET LE CHOIX DU CONCEPTEUR.
- 4) UNE ÉPAISSEUR DE 38MM MINIMUM EST RECOMMANDÉE POUR RECOUVRIR LA BARRE Z EXTÉRIEURE PAR L'INTÉRIEUR POUR COUPER LE PONT THERMIQUE.
- 5) LORSQUE LA LAME D'AIR INTÉRIEURE EST DE PLUS DE 25MM, L'ARTICLE 3.1.11.2 S'APPLIQUE.
- 6) HUNTSMAN SOLUTIONS BÂTIMENTS EST DISPONIBLE POUR LA RÉVISION DES DÉTAILS DU PROJET, POUR UNE RÉUNION DE COORDINATION AU DÉBUT DU PROJET ET POUR DES INSPECTIONS DE CHANTIER AU COURS DE LA RÉALISATION.

NOTES:

- A LE SOLIN SOUPLE AU DESSUS DES OUVERTURES DOIT EXCÉDER MIN. 200mm (8") DE CHAQUE COTÉ DE L'OUVERTURE
- B REMONTER LA MEMBRANE DE CHAQUE COTÉ DES JAMBAGES MIN. 75mm (3")
- C LES MEMBRANES DOIVENT ÊTRE INSTALLÉES SELON LES EXIGENCES DES MANUFACTURIERS

NOTES: UNE MEMBRANE PLEINE SURFACE PEUT ÊTRE UTILISÉE SELON LE CHOIX DE CONCEPTION (NON ILLUSTRÉ)

Date: 03-05-2022

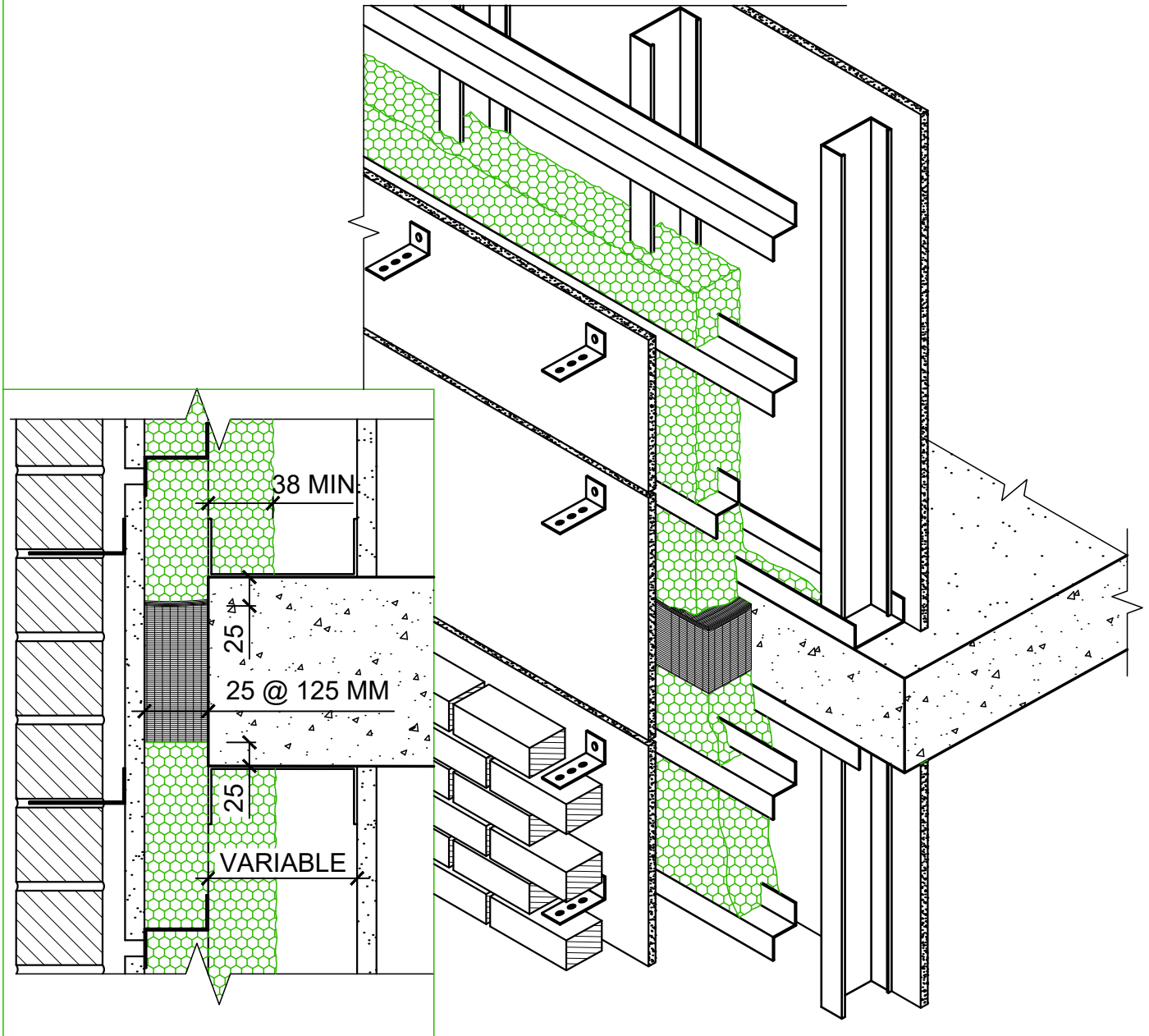

ISOMÉTRIE
REVÊTEMENT DE BRIQUE

Date:03-05-2022

Échelle: Variable

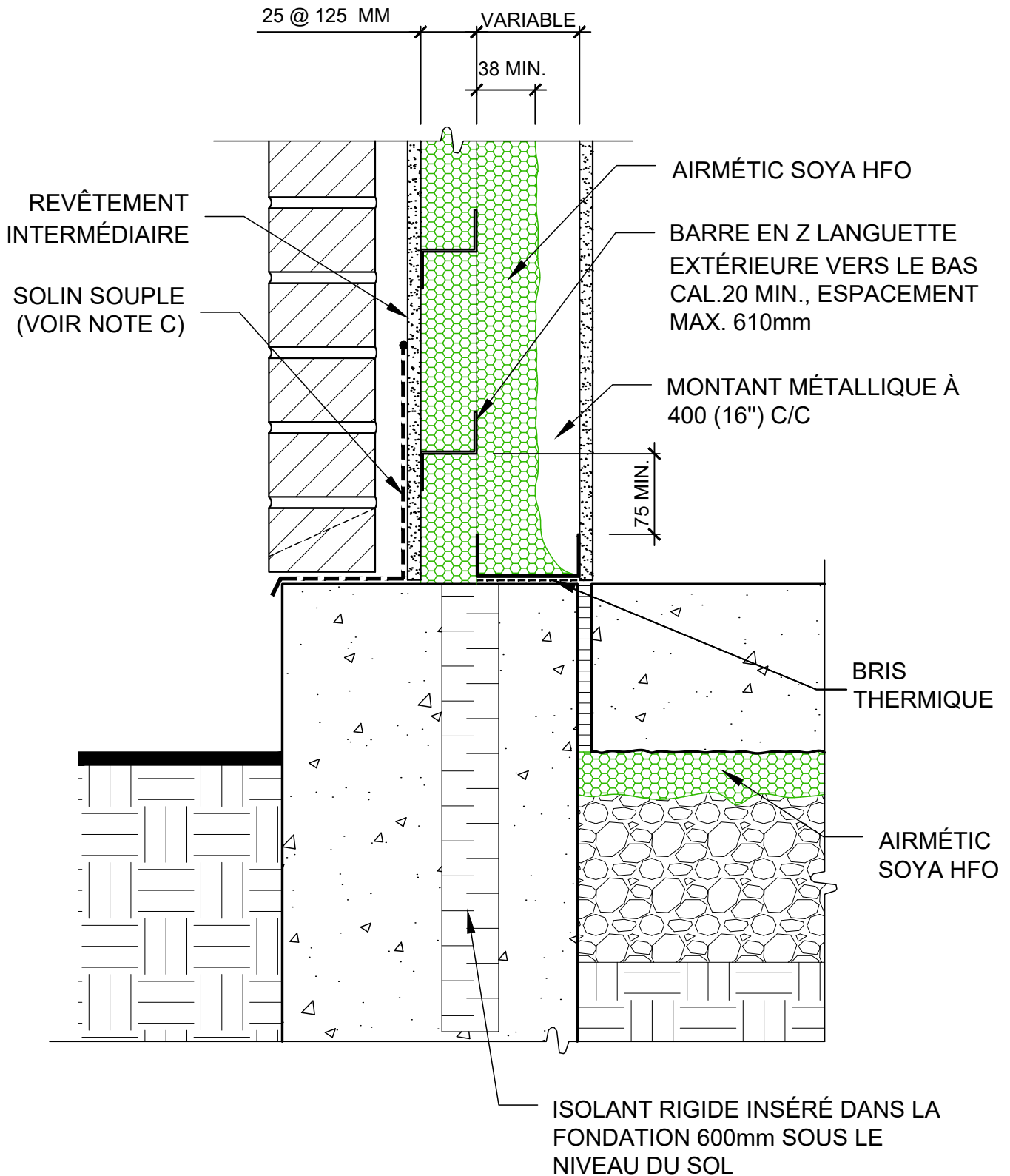

MUR / SOLIN SOUPLE, AUX FONDATIONS
REVÊTEMENT DE BRIQUE

Date: 03-05-2022

Échelle: 1:5

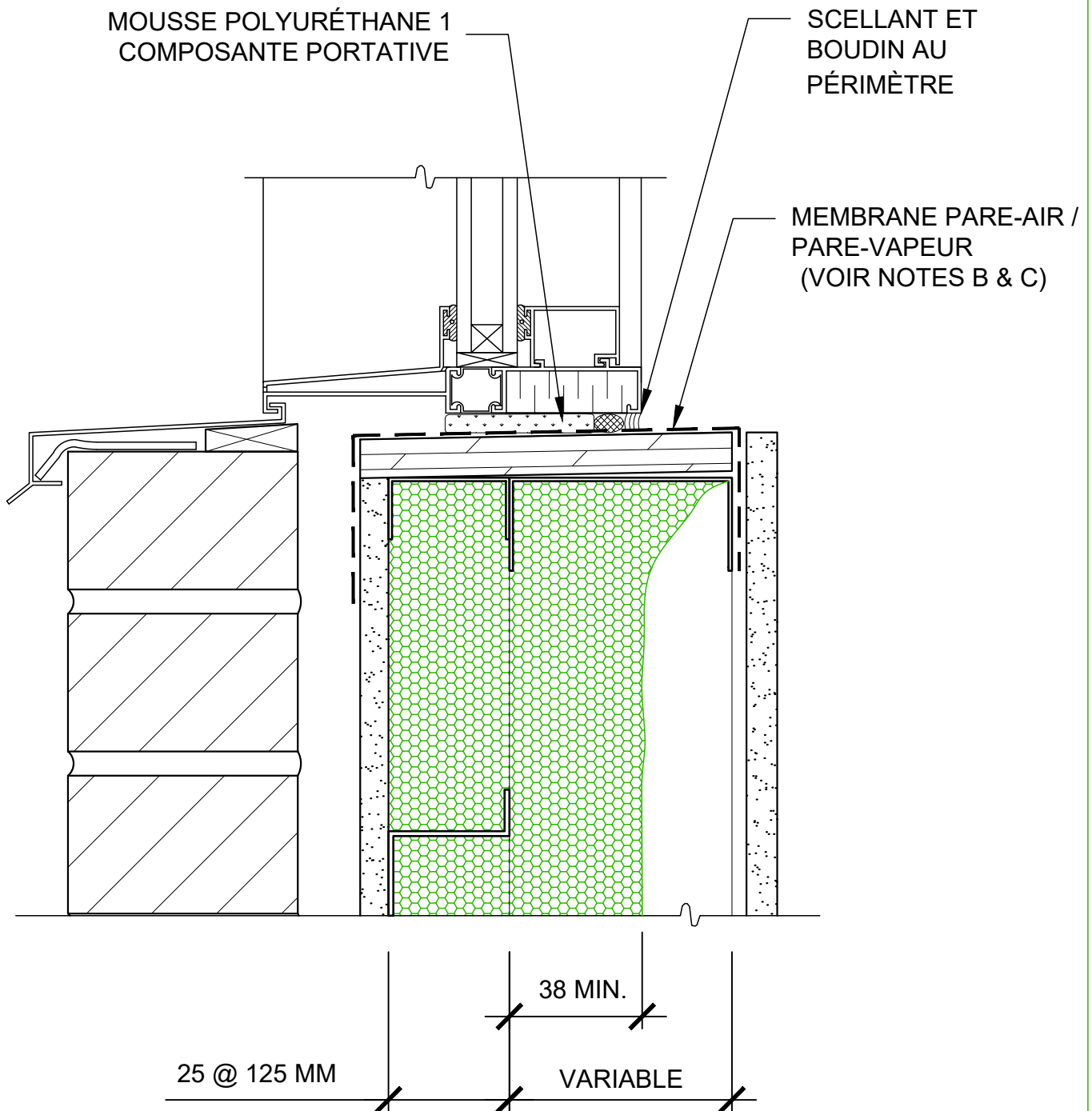

SEUIL DE FENÊTRE
REVÊTEMENT DE BRIQUE

Date: 03-05-2022

Échelle: 1:2.5

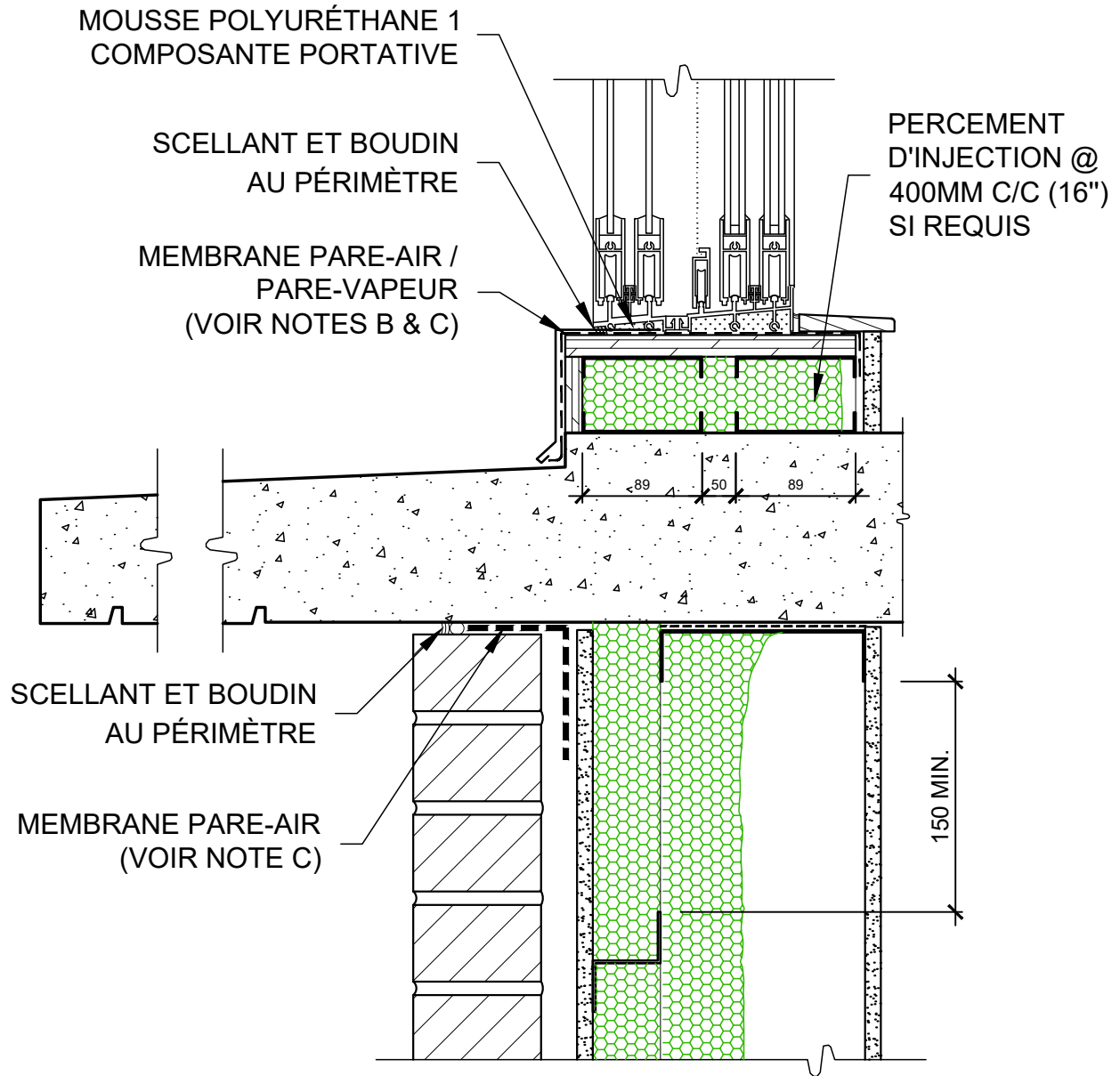

JONCTION BALCON / DALLE
REVÊTEMENT DE BRIQUES

Date: 03-05-2022

Échelle: 1:5

NOTE: POUR FIN DE SUPPORT AUX OUVERTURES, LES POTEAUX DE SUPPORTS DE FENÊTRES PEUVENT ÊTRE DOUBLÉS ET INJECTÉS AVEC AIRMÉTIC SOYA HFO.

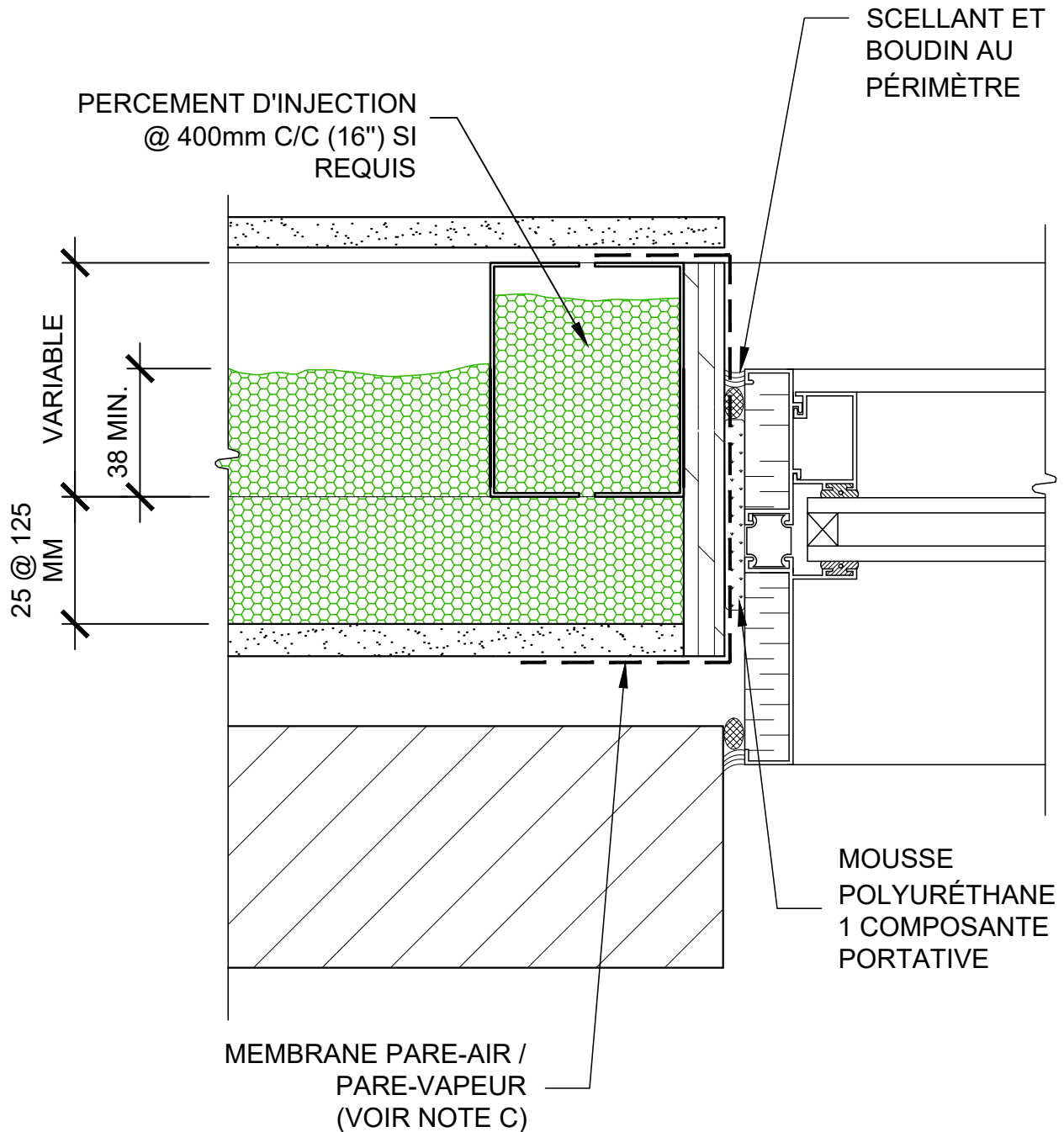

JAMBAGE DE FENÊTRE
REVÊTEMENT DE BRIQUE

Date: 03-05-2022

Échelle: 1:2.5

SOLIN SOUPLE (VOIR NOTES A & C)

25 @ 125 MM VARIABLE

38 MIN.

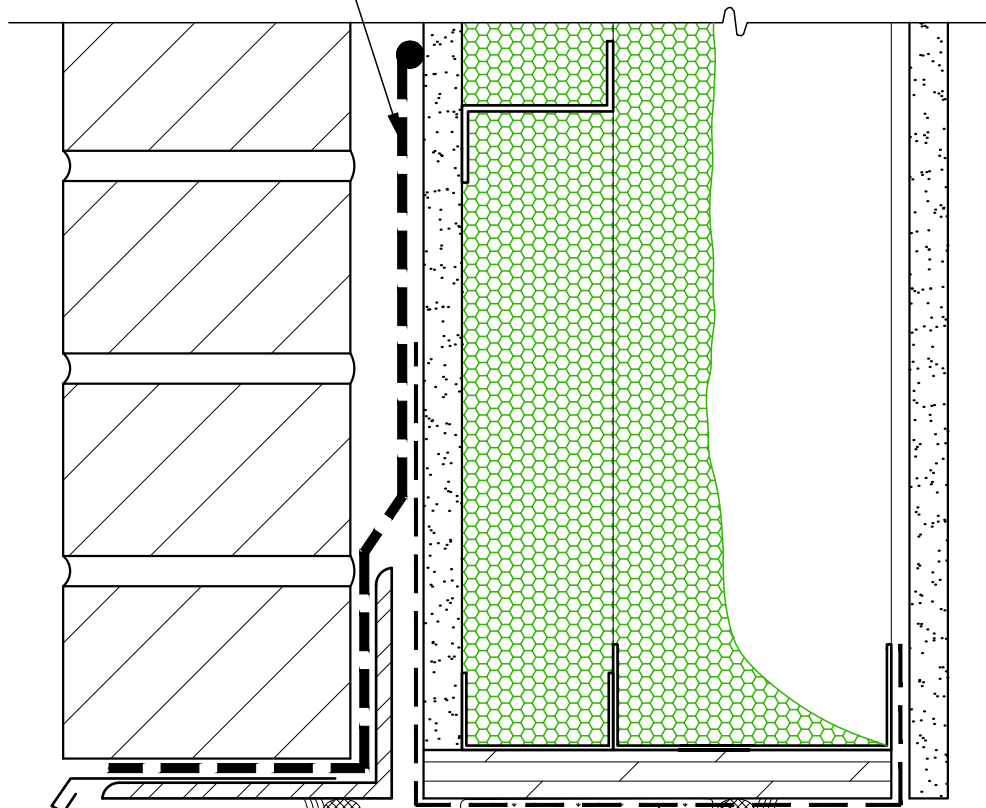

SCELLANT ET BOUDIN
AU PÉRIMÈTRE

MOUSSE POLYURÉTHANE 1
COMPOSANTE PORTATIVE

MEMBRANE PARE-AIR /
PARE-VAPEUR
(VOIR NOTE C)

TÊTE DE FENÊTRE
REVÊTEMENT DE BRIQUE

Date: 03-05-2022

Échelle: 1:2.5

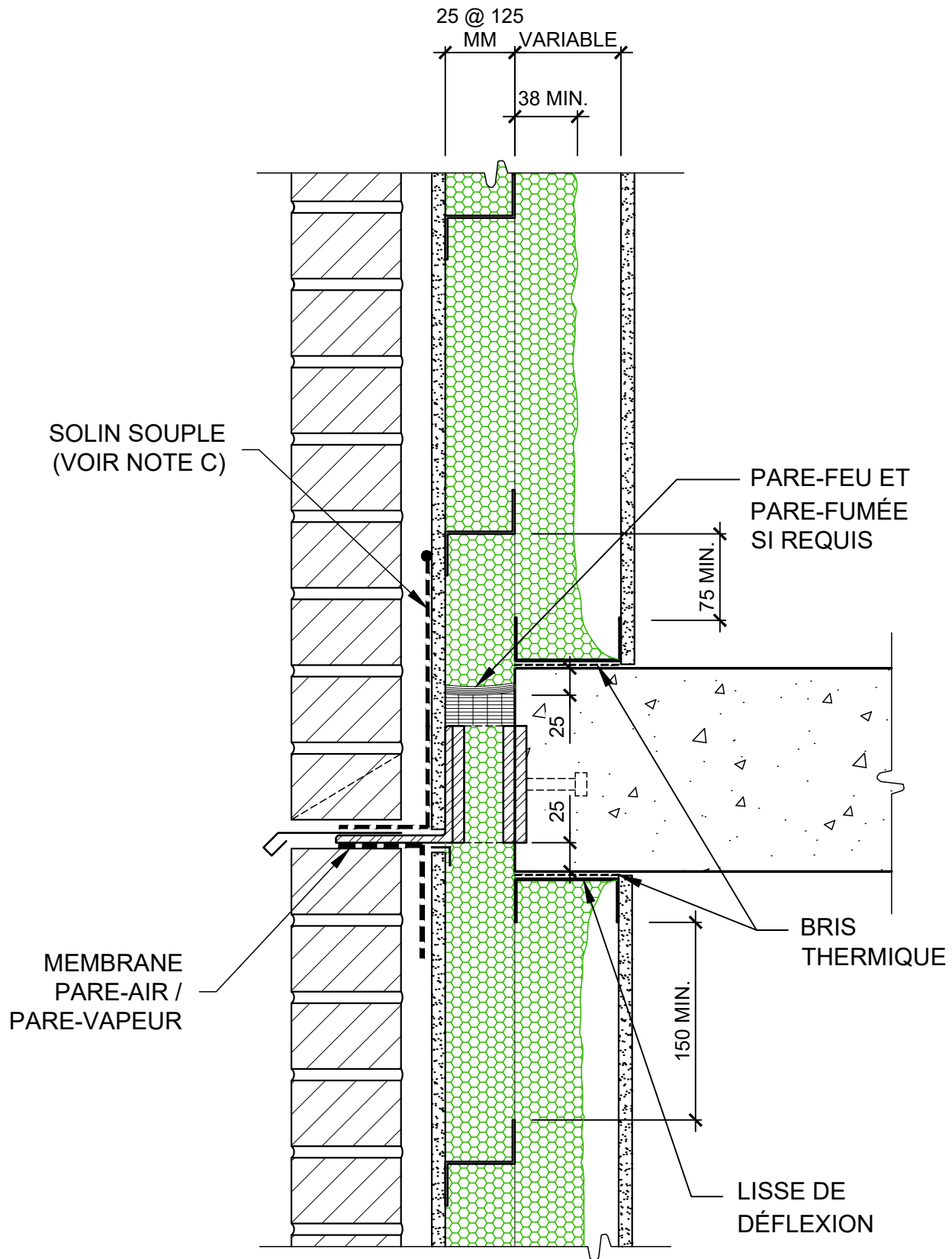

JONCTION PLANCHER
REVÊTEMENT DE BRIQUE

Date: 03-05-2022

Échelle: 1:5

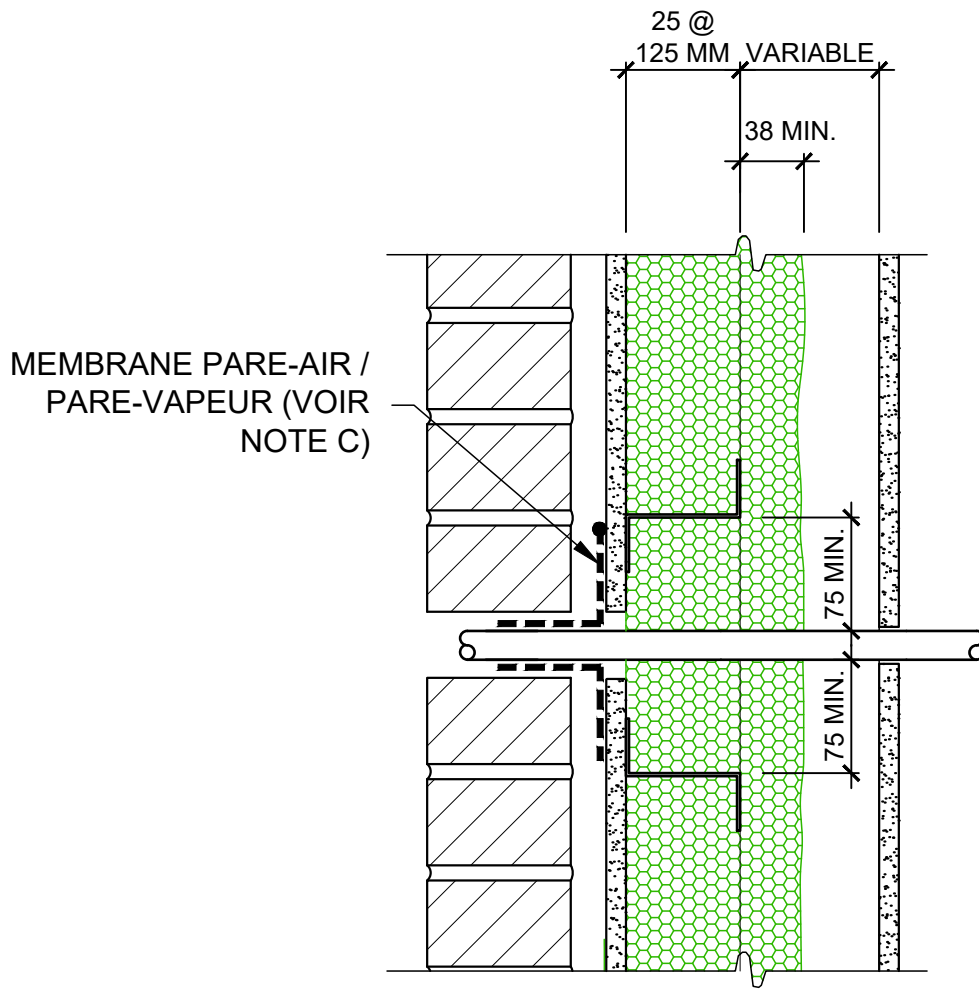

PERFORATIONS, ACCESSOIRES
REVÊTEMENT DE BRIQUE

Date: 03-05-2022

Échelle: 1:5

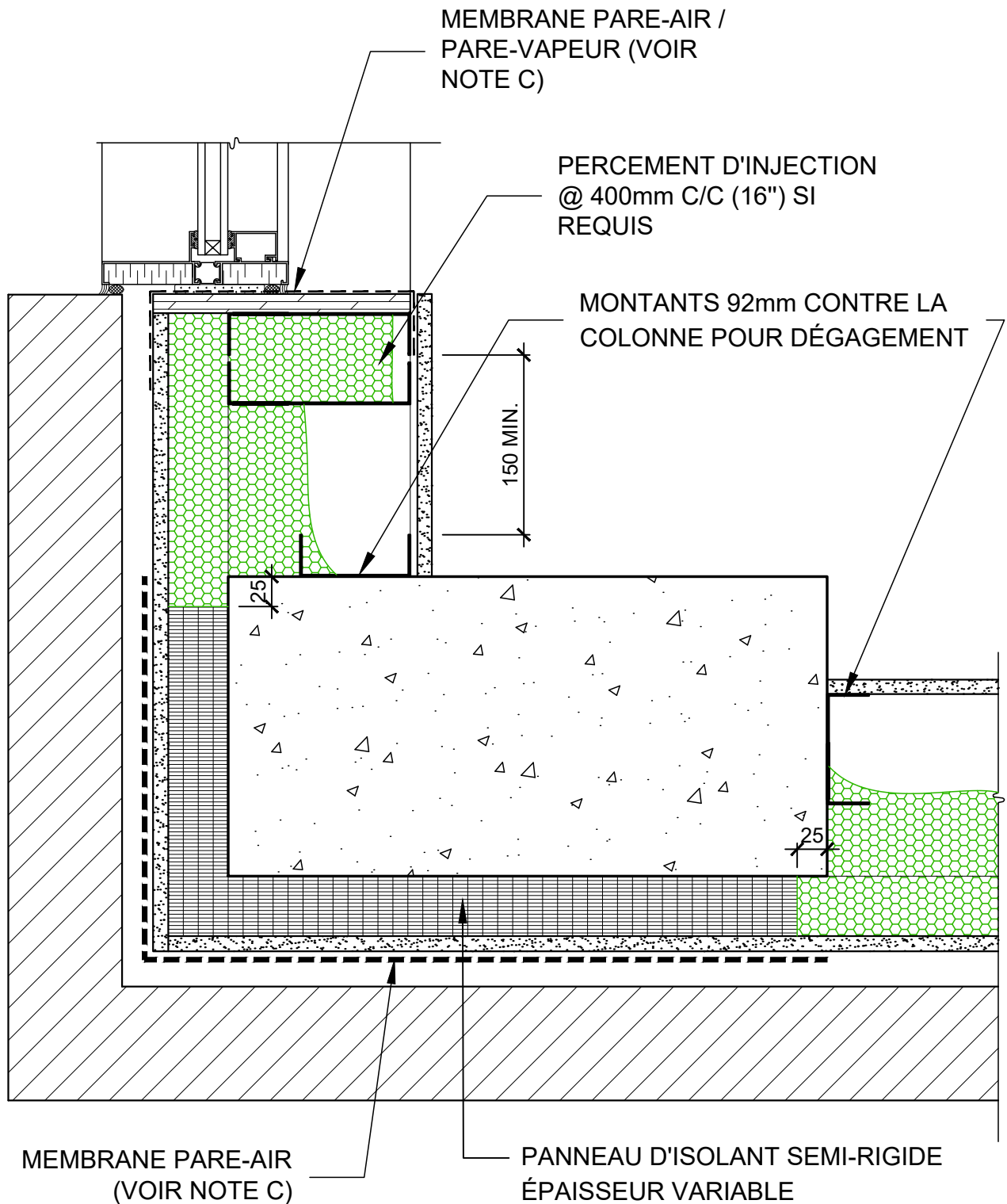

JONCTION COLONNE ET MUR - COIN DE BÂTIMENT
REVÊTEMENT DE BRIQUE

Date: 03-05-2022

Échelle: 1:5

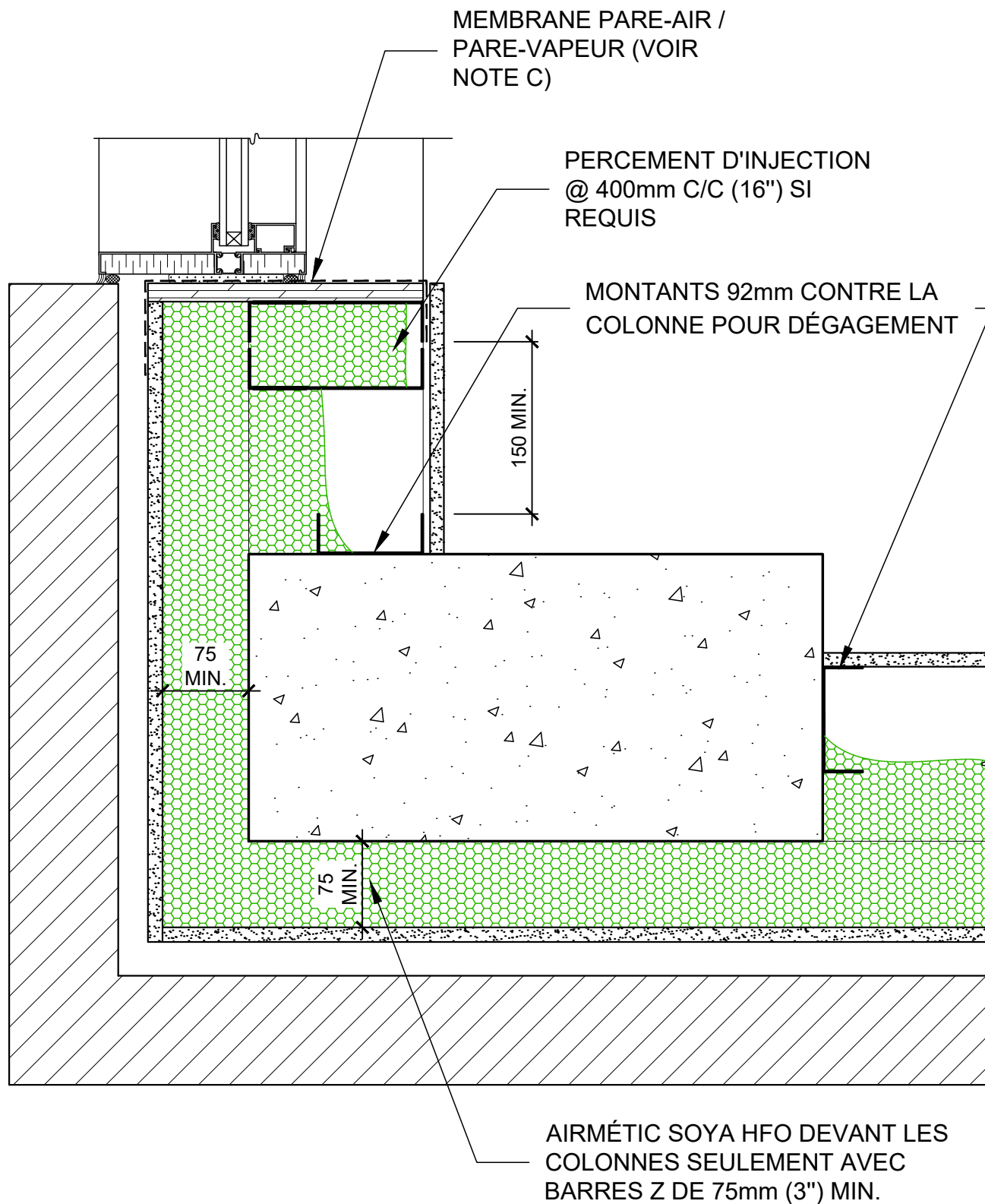

JONCTION COLONNE ET MUR - COIN DE BÂTIMENT
REVÊTEMENT DE BRIQUE

Date: 03-05-2022

Échelle: 1:5

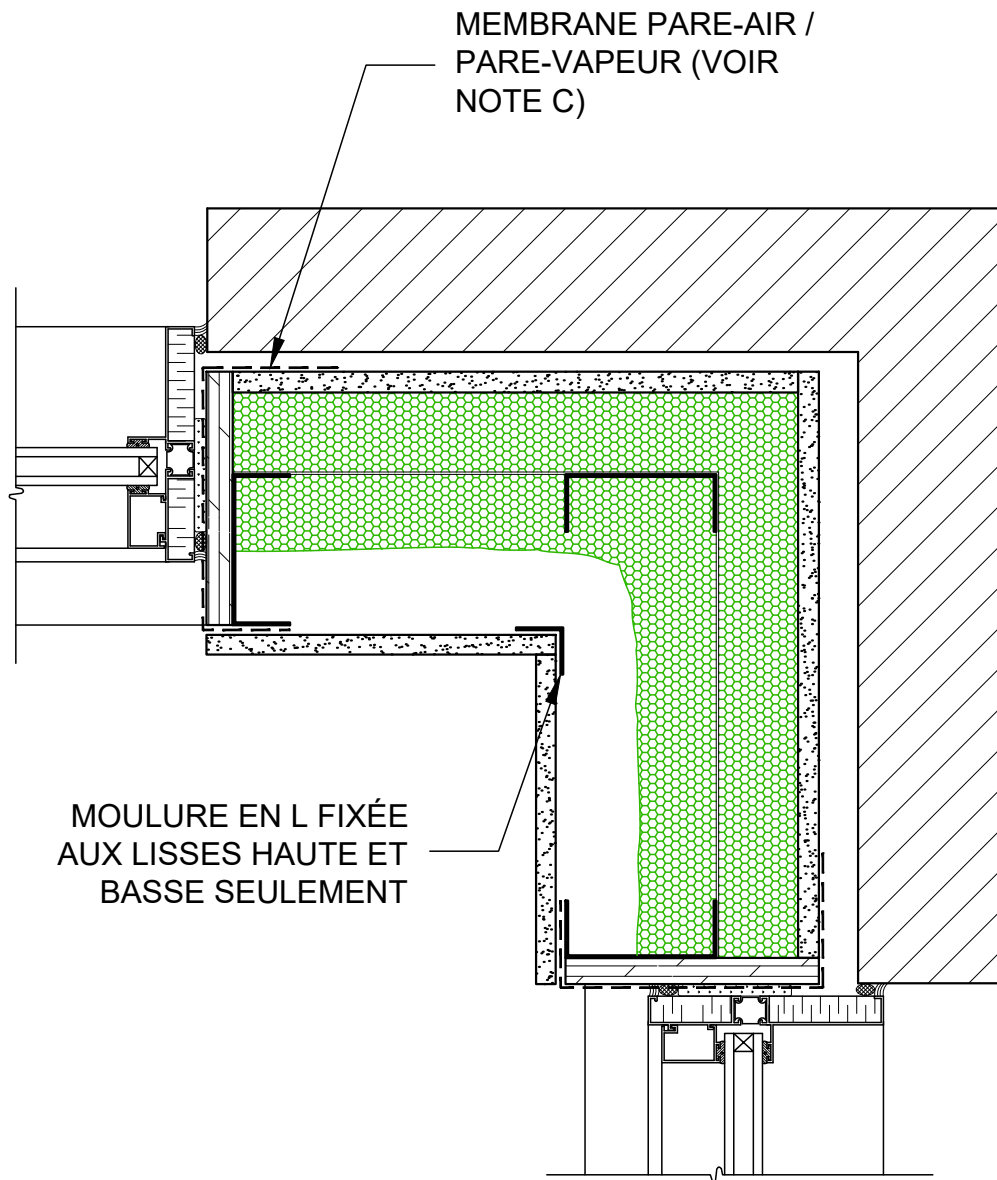

COIN DE BÂTIMENT - POSITION DES MONTANTS
REVÊTEMENT DE BRIQUE

Date: 03-05-2022

Échelle: 1:5

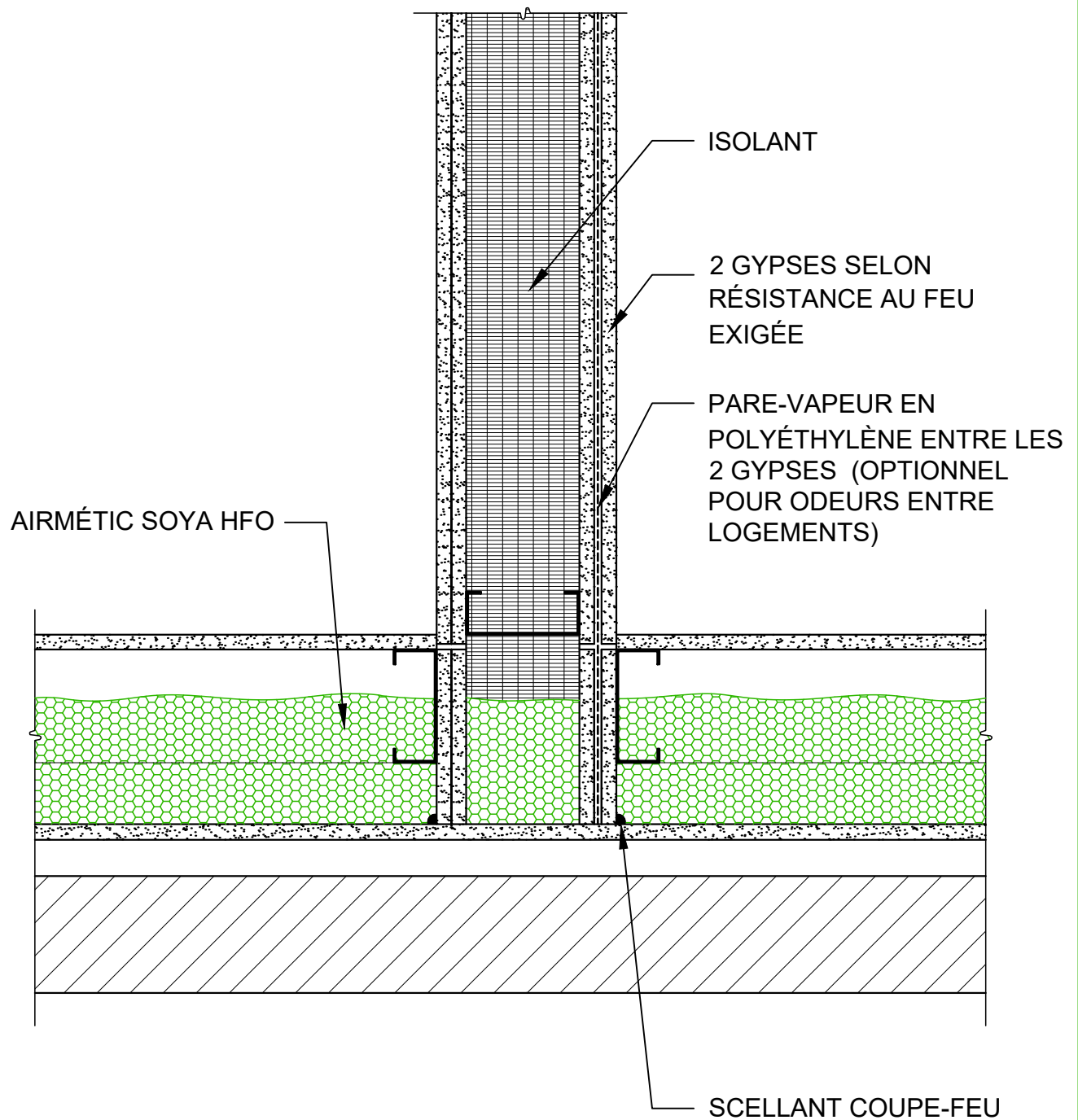

SÉPARATION COUPE-FEU
REVÊTEMENT DE BRIQUE

Date: 03-05-2022

Échelle: 1:5

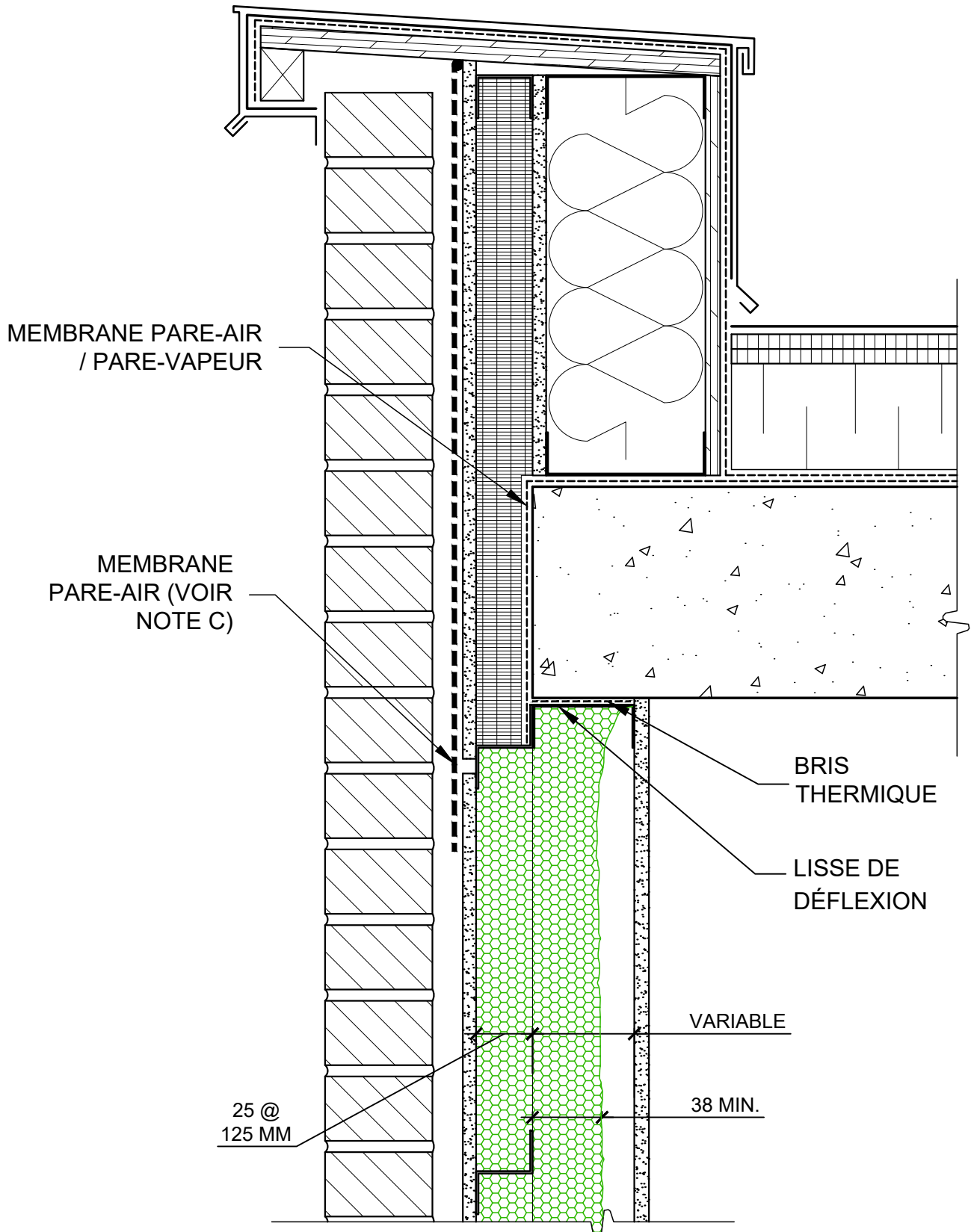

PARAPET / AIRMETIC SOYA HFO INTÉRIEUR POUTRE
 REVÊTEMENT DE BRIQUE

Date: 03-05-2022

Échelle: 1:5

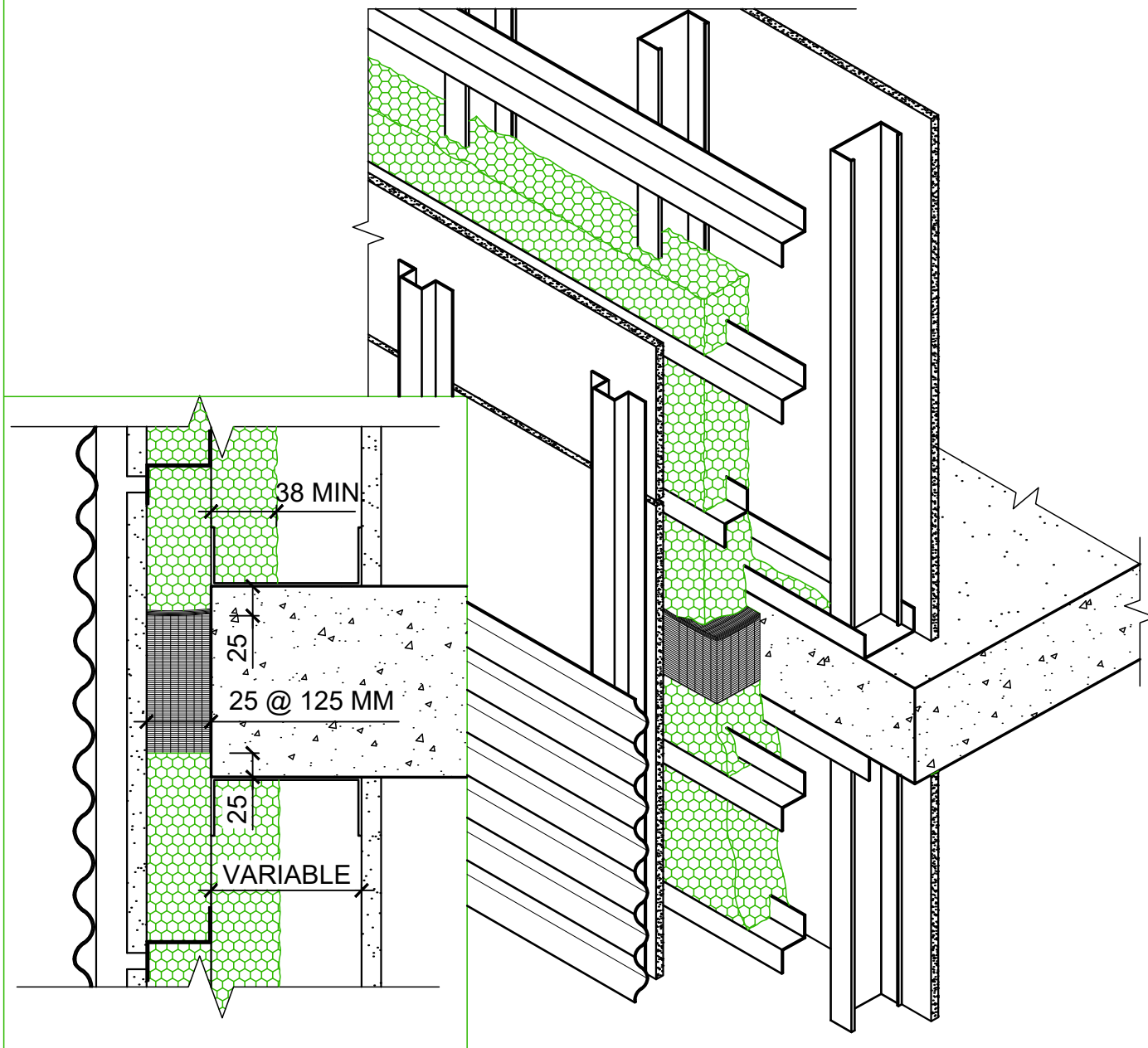

ISOMÉTRIE
REVÊTEMENT LÉGER

Date:03-05-2022

Échelle: Variable

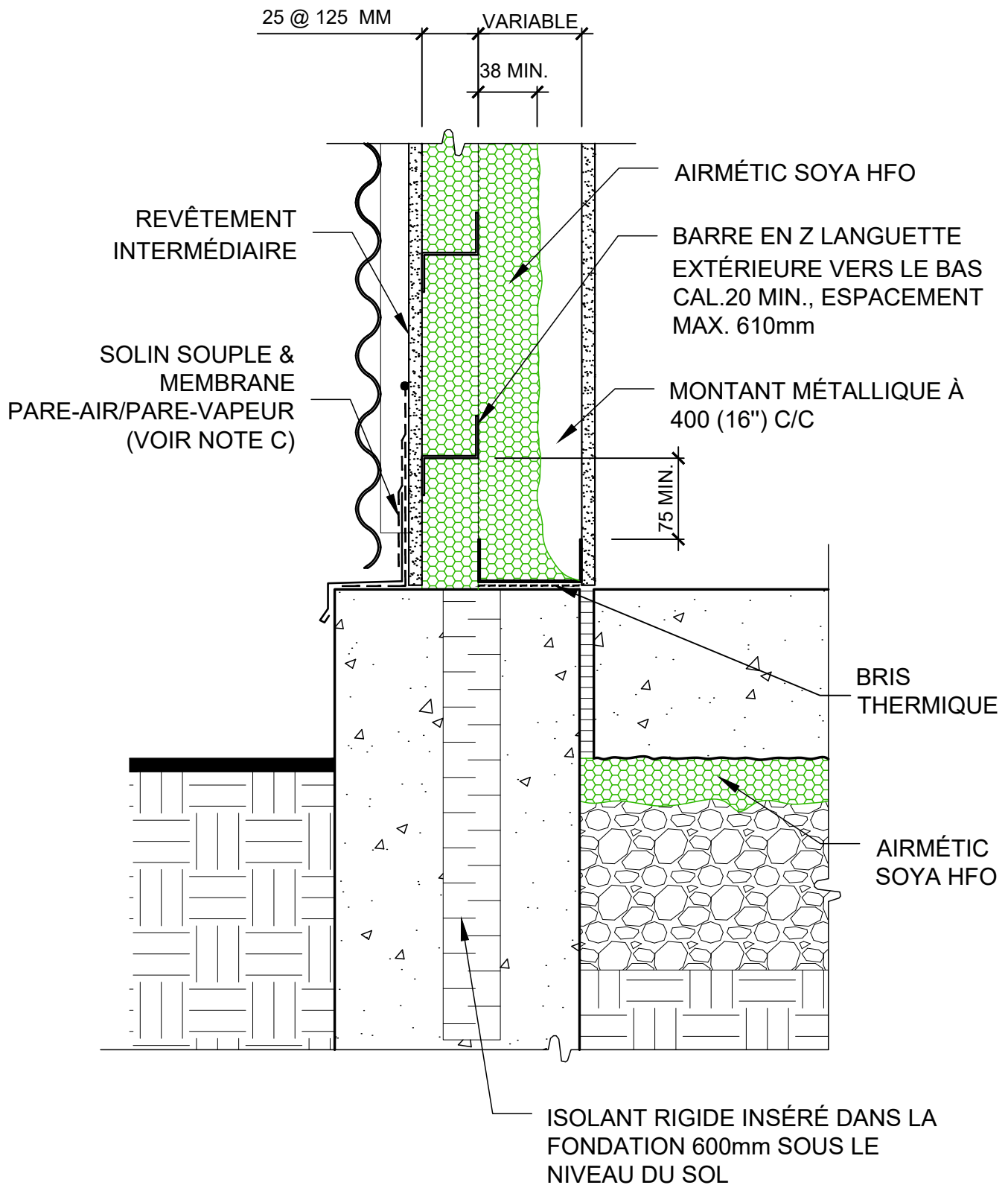

MUR / SOLIN SOUPLE, AUX FONDATIONS
REVÊTEMENT LÉGER

Date: 03-05-2022

Échelle: 1:5

MOUSSE POLYURÉTHANE 1
COMPOSANTE PORTATIVE

SCÉLLANT ET
BOUDIN AU
PÉRIMÈTRE

MEMBRANE PARE-AIR /
PARE-VAPEUR
(VOIR NOTES B & C)

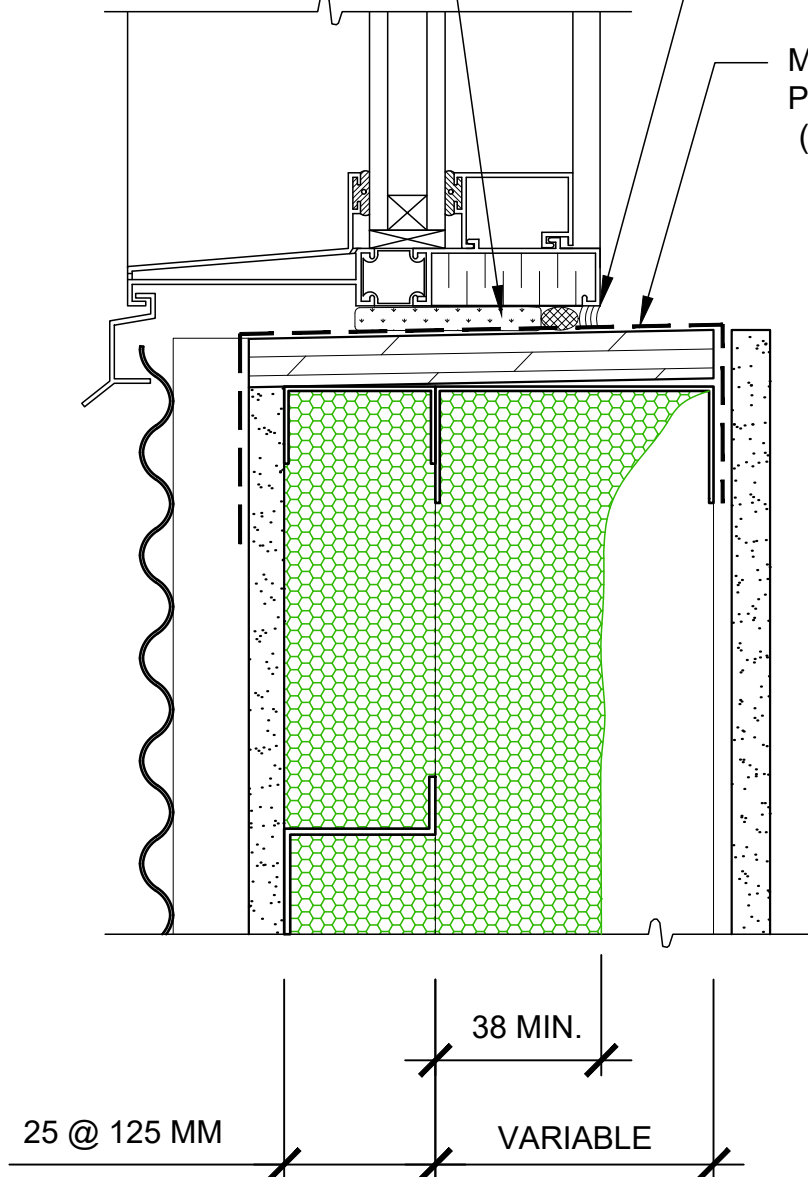

SEUIL DE FENÊTRE
REVÊTEMENT LÉGER

Date: 03-05-2022

Échelle: 1:2.5

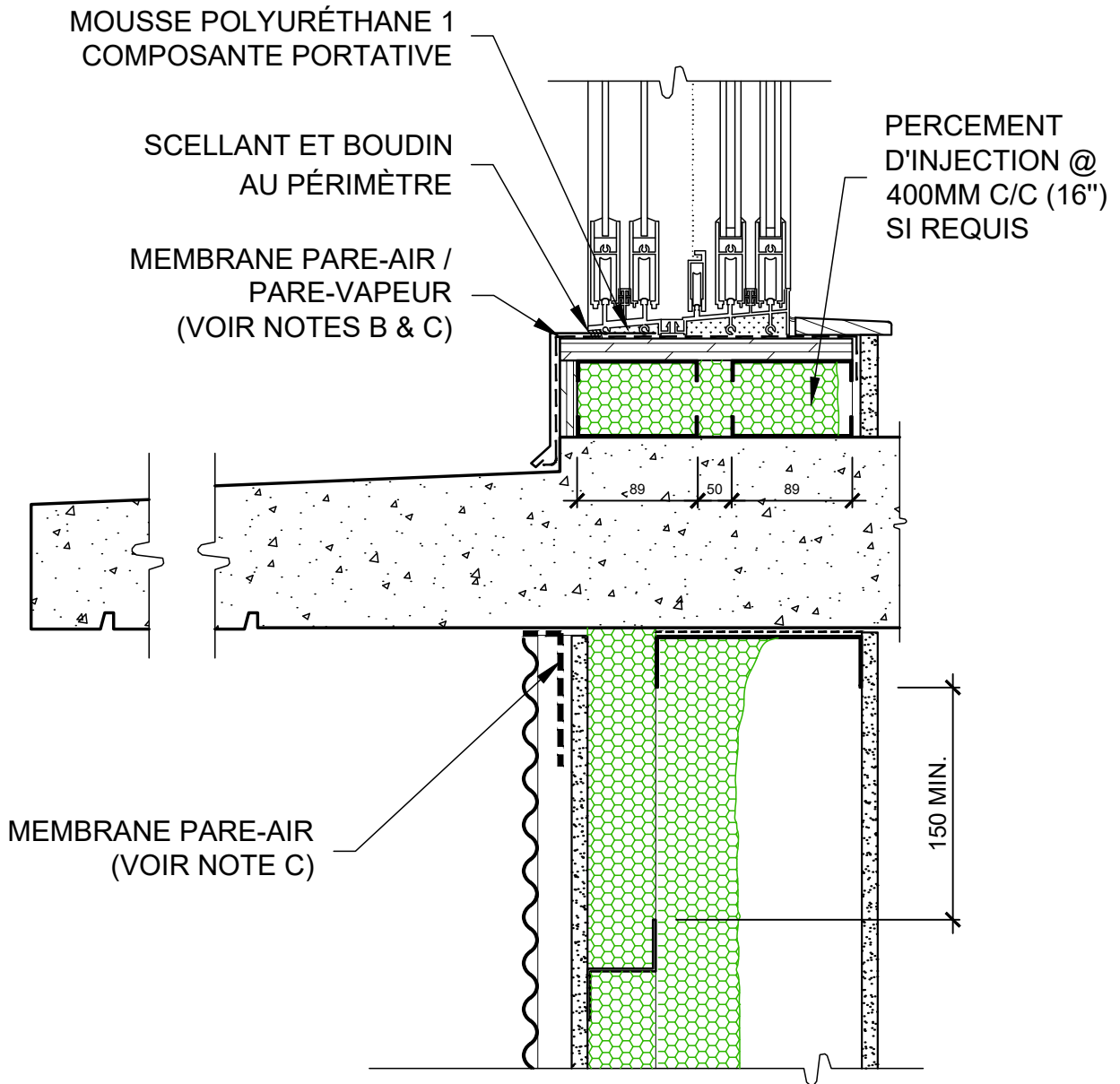

JONCTION BALCON / DALLE
REVÊTEMENT LÉGER

Date: 03-05-2022

Échelle: 1:5

NOTE: POUR FIN DE SUPPORT AUX
OUVERTURES, LES POTEAUX DE
SUPPORTS DE FENÊTRES PEUVENT
ÊTRE DOUBLÉS ET INJECTÉS AVEC
AIRMÉTIC SOYA HFO.

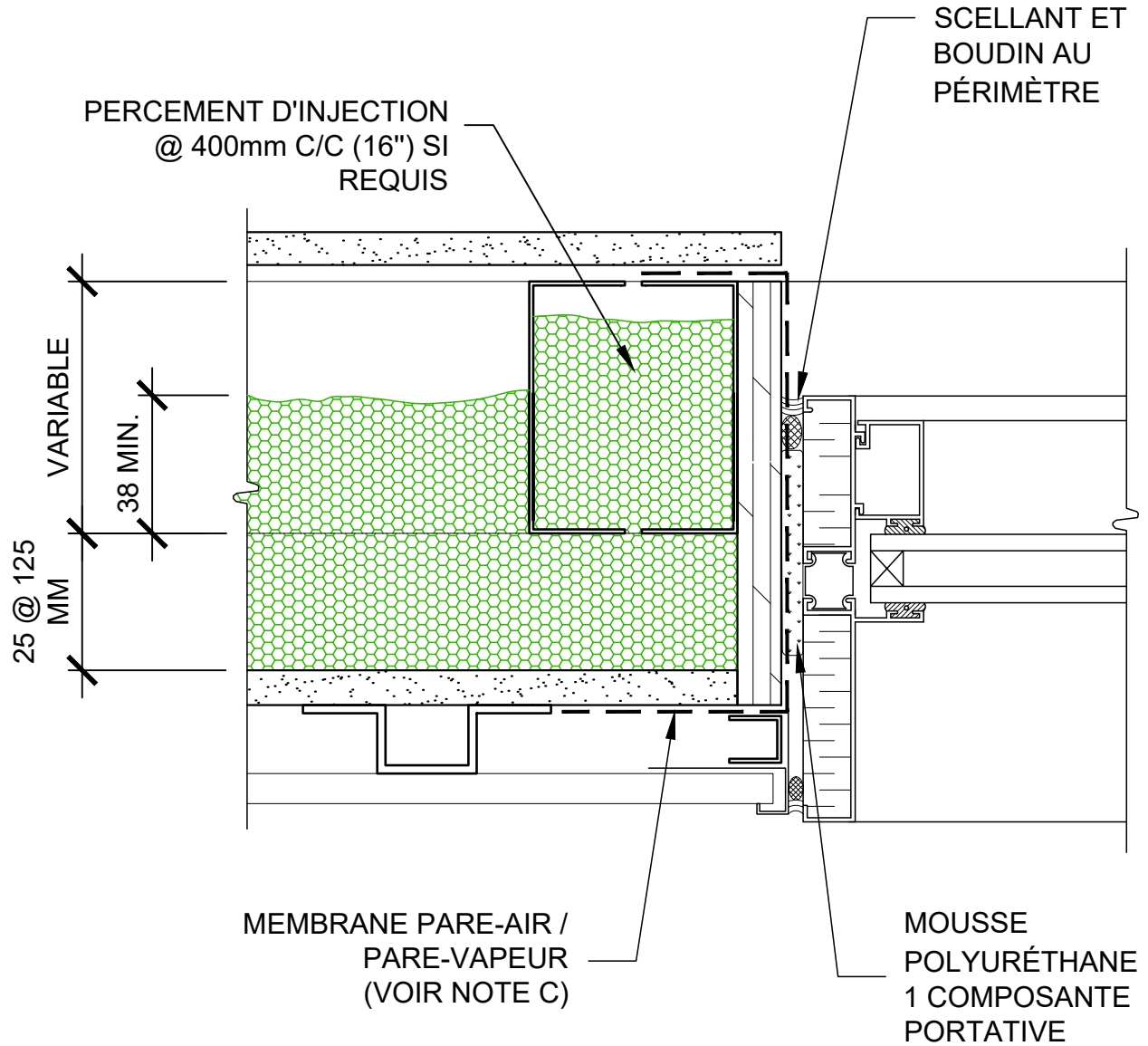

JAMBAGE DE FENÊTRE
REVÊTEMENT LÉGER

Date: 03-05-2022

Échelle: 1:2.5

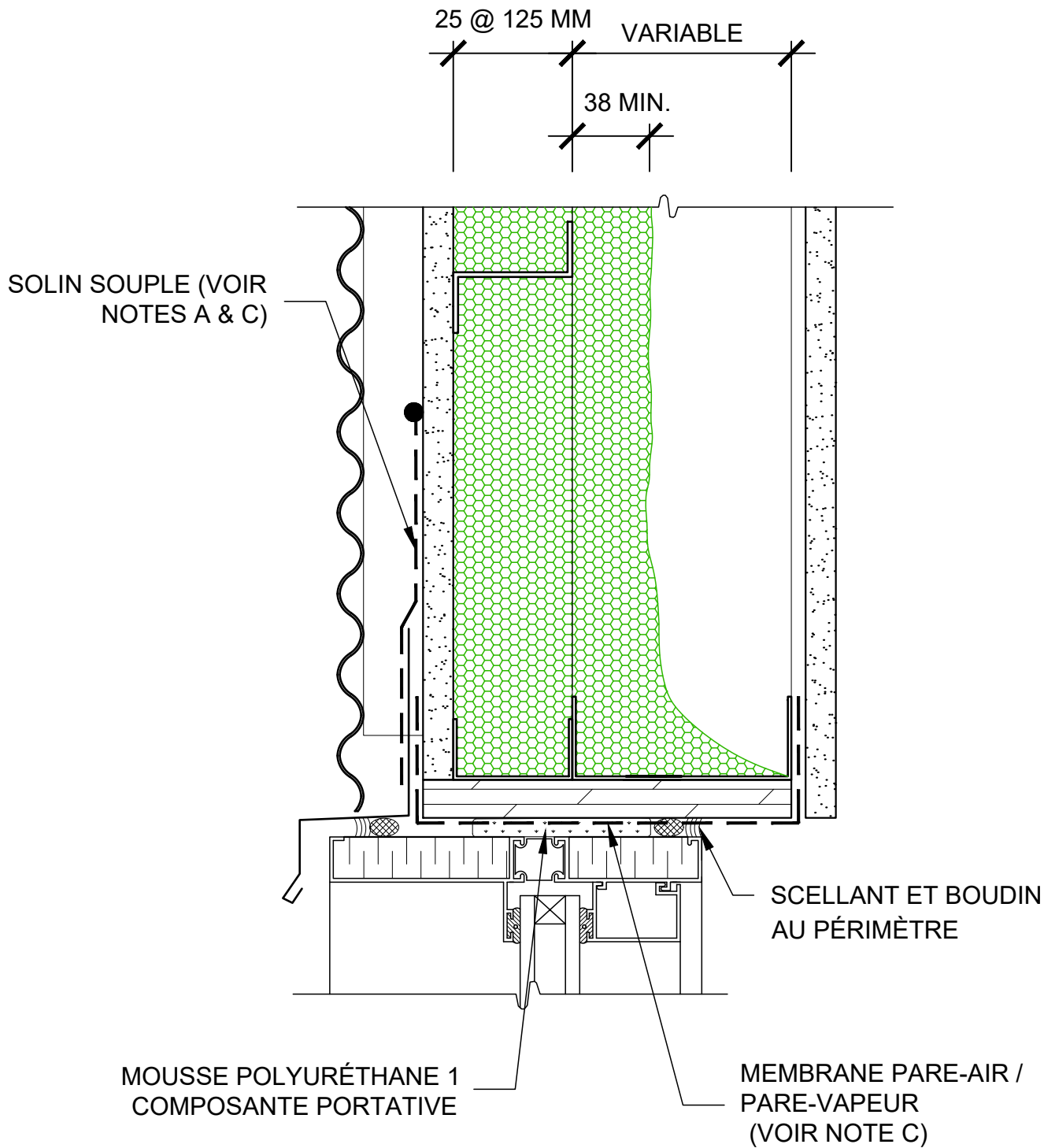

TÊTE DE FENÊTRE
REVÊTEMENT LÉGER

Date: 03-05-2022

Échelle: 1:2.5

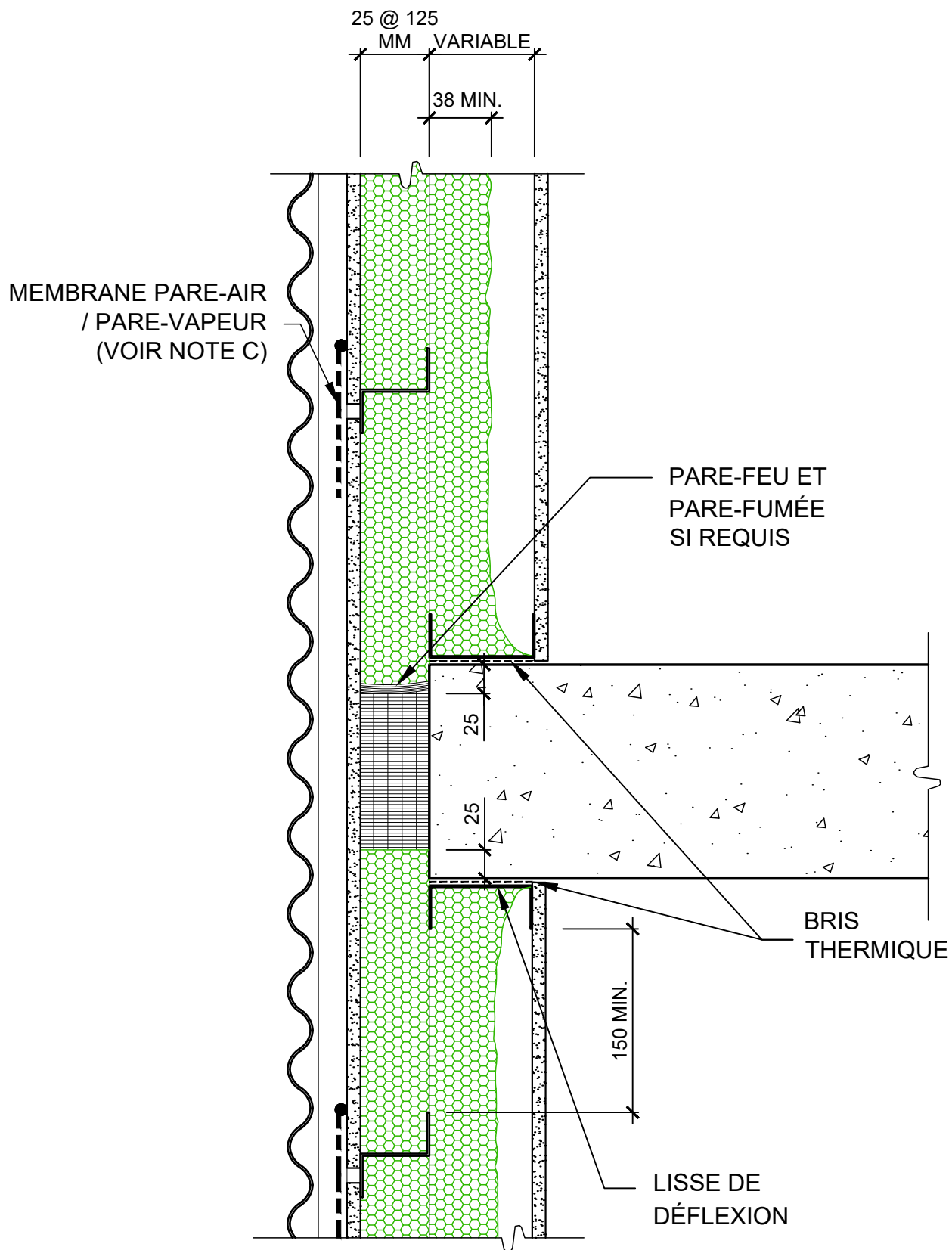

JONCTION PLANCHER
REVÊTEMENT LÉGER

Date: 03-05-2022

Échelle: 1:5

HUNTSMAN
SOLUTIONS BÂTIMENTS

MUR D-MAX

PAGE 20

AIRMÉTIC® SOYA HFO™

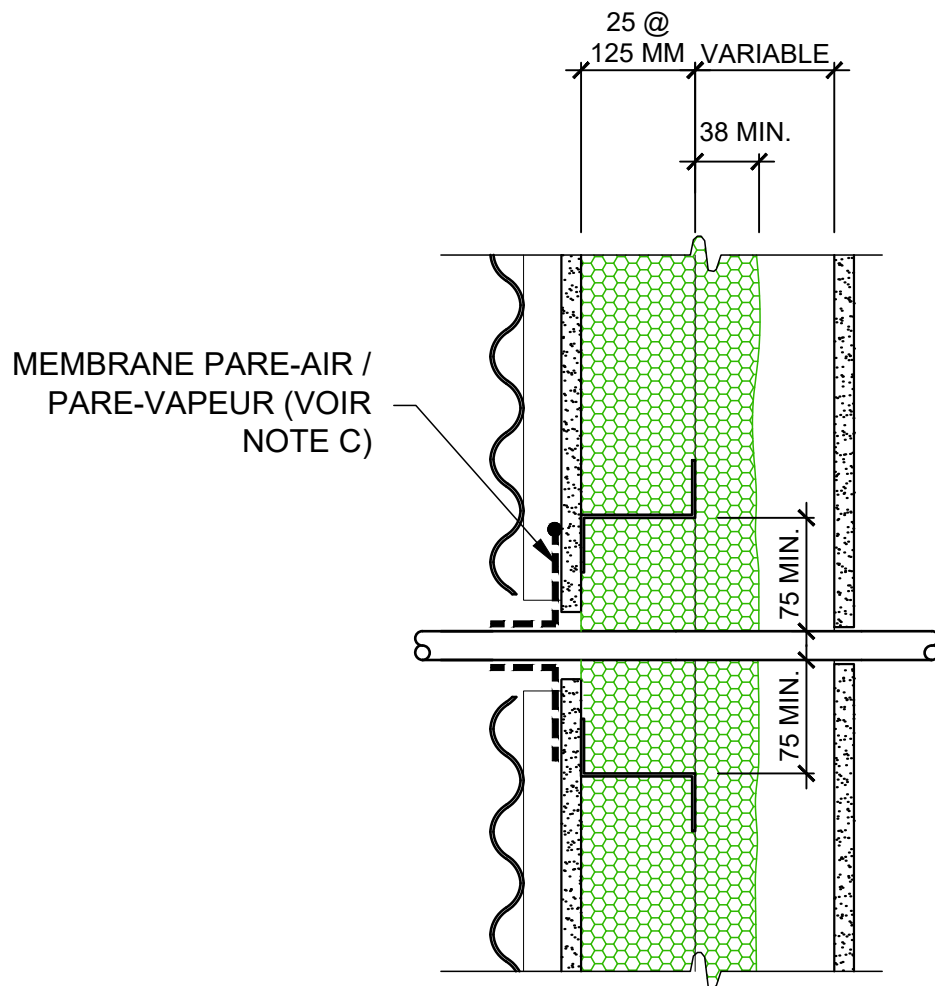

PERFORATIONS, ACCESSOIRES
REVÊTEMENT LÉGER

Date: 03-05-2022

Échelle: 1:5

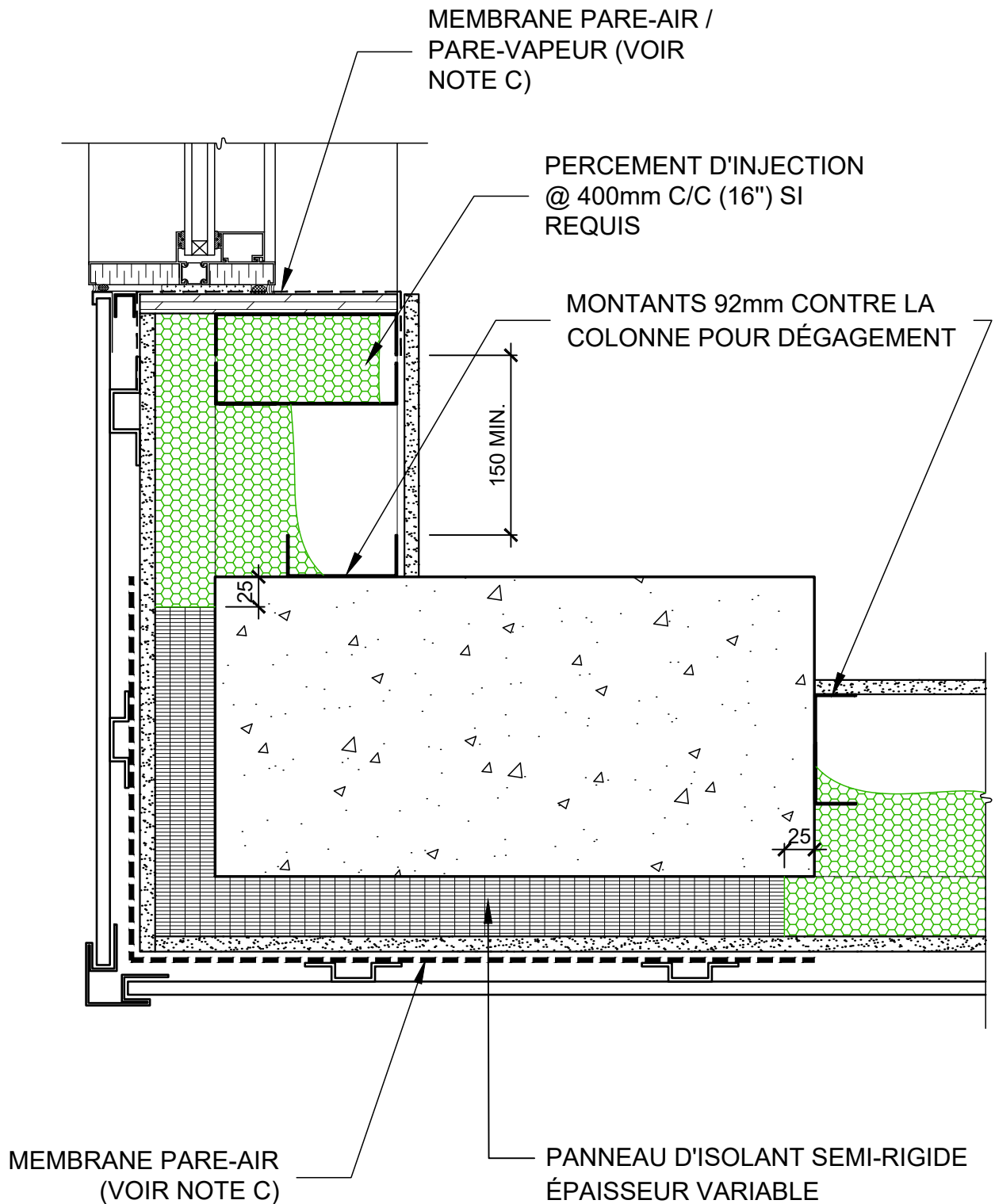

JONCTION COLONNE ET MUR - COIN DE BÂTIMENT
REVÊTEMENT LÉGER

Date: 03-05-2022

Échelle: 1:5

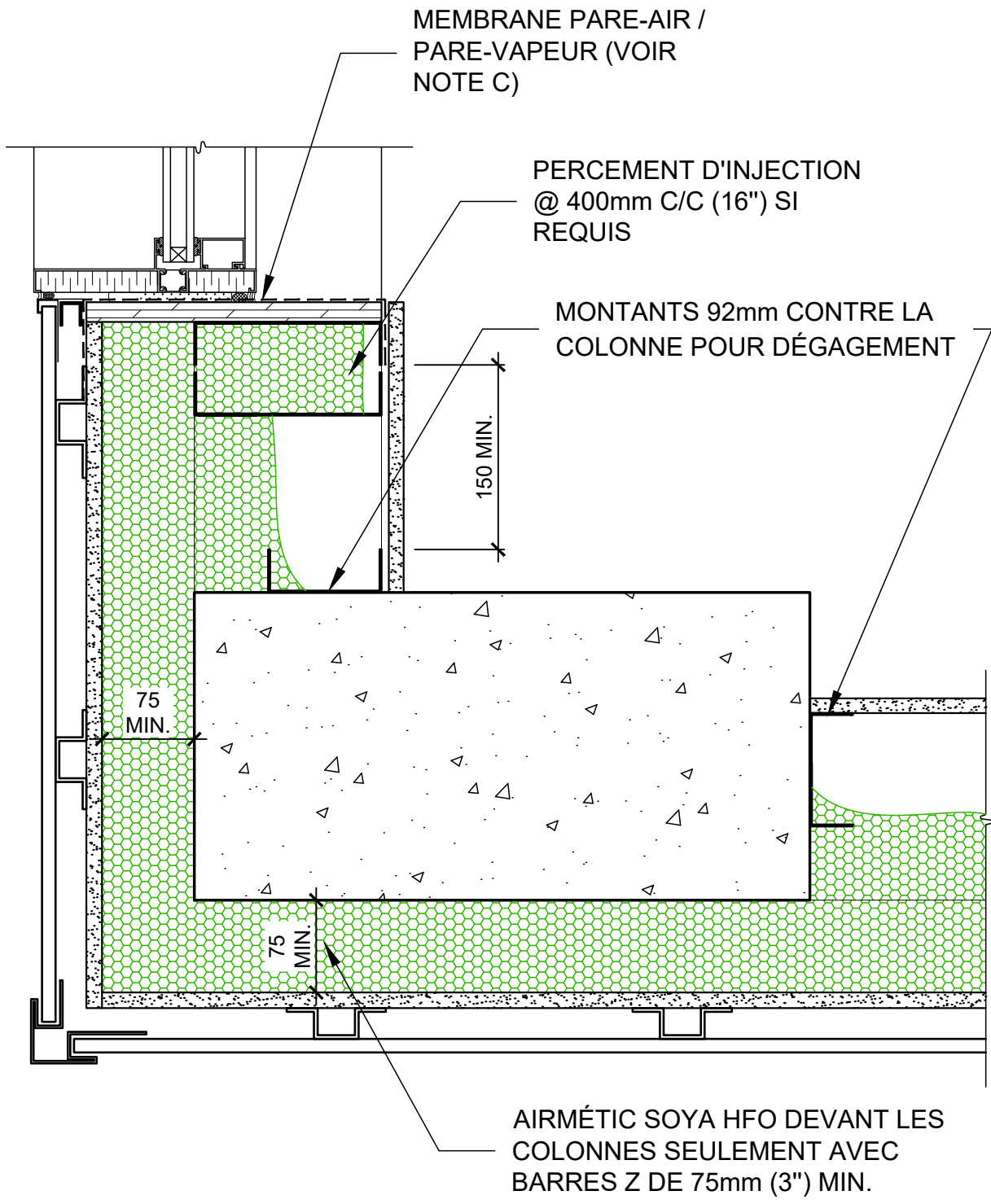

JONCTION COLONNE ET MUR - COIN DE BÂTIMENT
 REVÊTEMENT LÉGER

Date: 03-05-2022

Échelle: 1:5

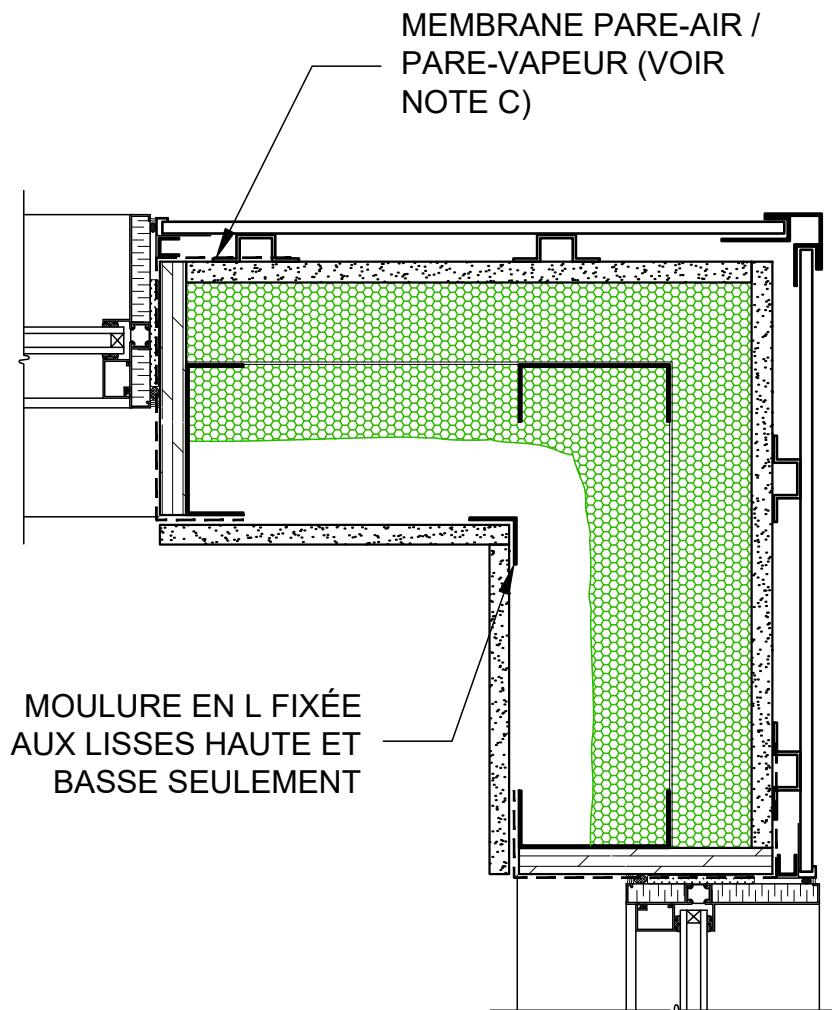

COIN DE BÂTIMENT - POSITION DES MONTANTS
REVÊTEMENT LÉGER

Date: 03-05-2022

Échelle: 1:5

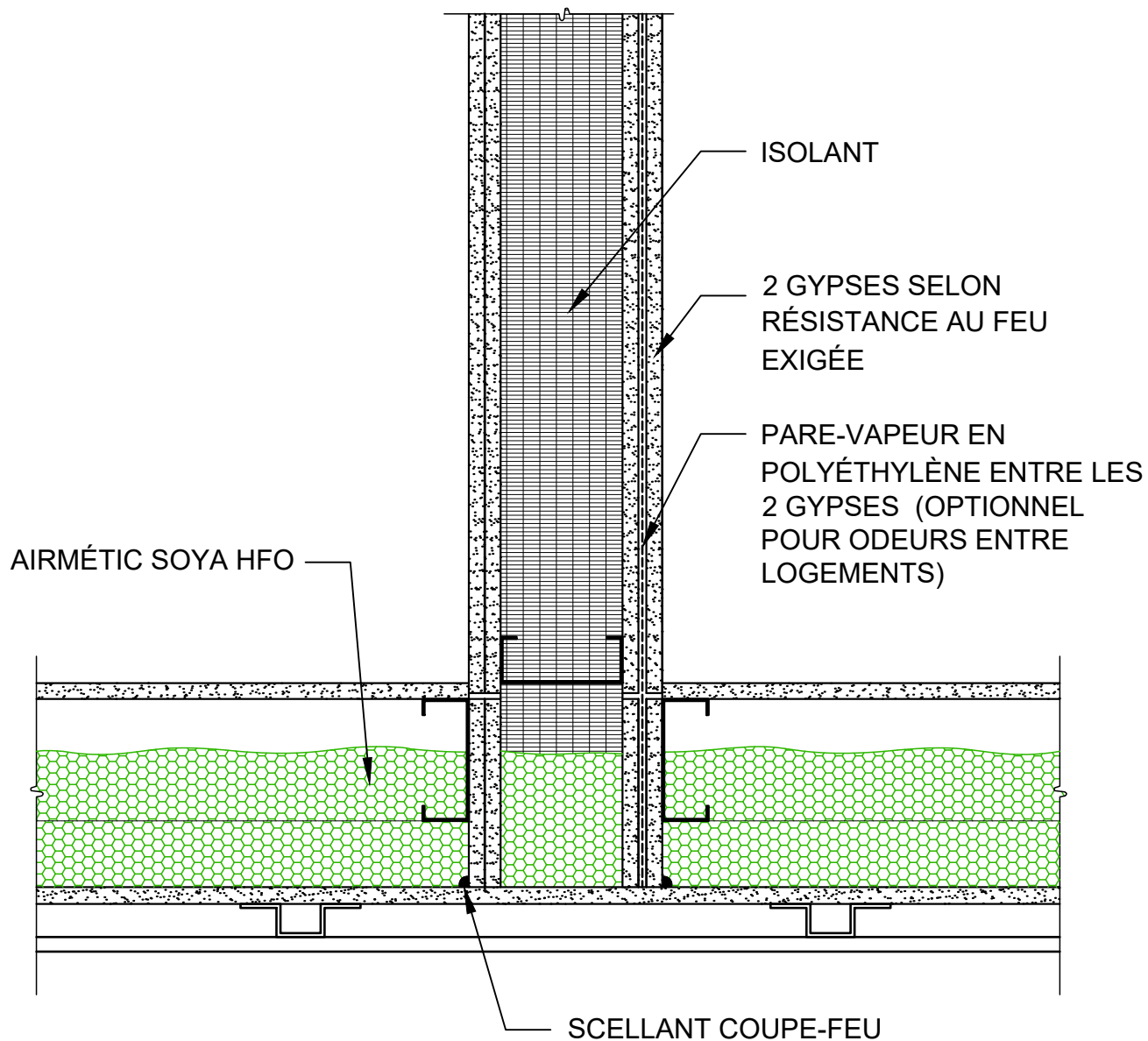

SÉPARATION COUPE-FEU
REVÊTEMENT LÉGER

Date: 03-05-2022

Échelle: 1:5

MEMBRANE PARE-AIR / PARE-VAPEUR

MEMBRANE PARE-AIR (VOIR NOTE C)

BRIS THERMIQUE

LISSE DE DÉFLEXION

VARIABLE

25 @ 125 MM

38 MIN.

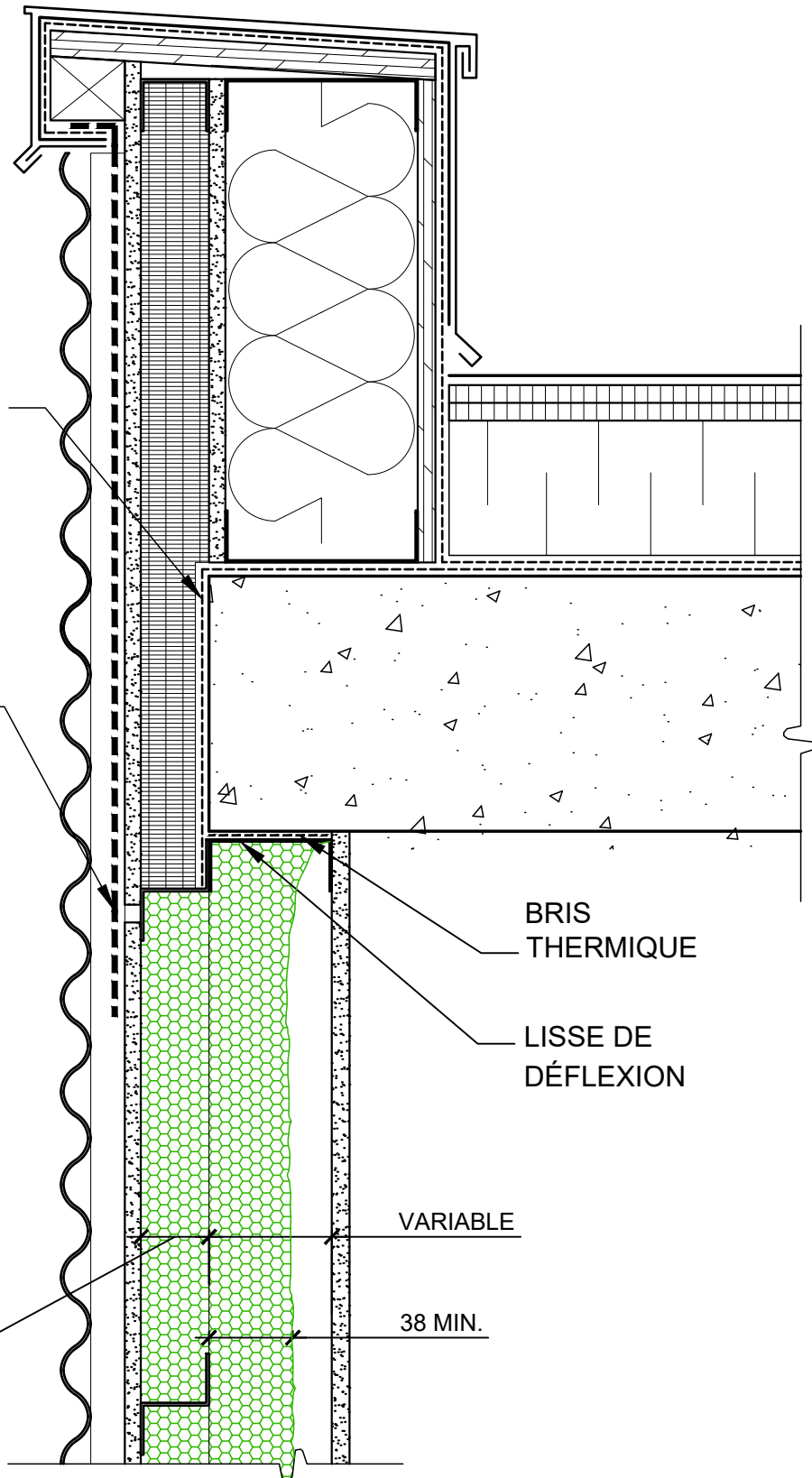

PARAPET / AIRMETIC SOYA HFO INTÉRIEUR POUTRE
REVÊTEMENT LÉGER

Date: 03-05-2022

Échelle: 1:5

OPTIONS

Date: 03-05-2022

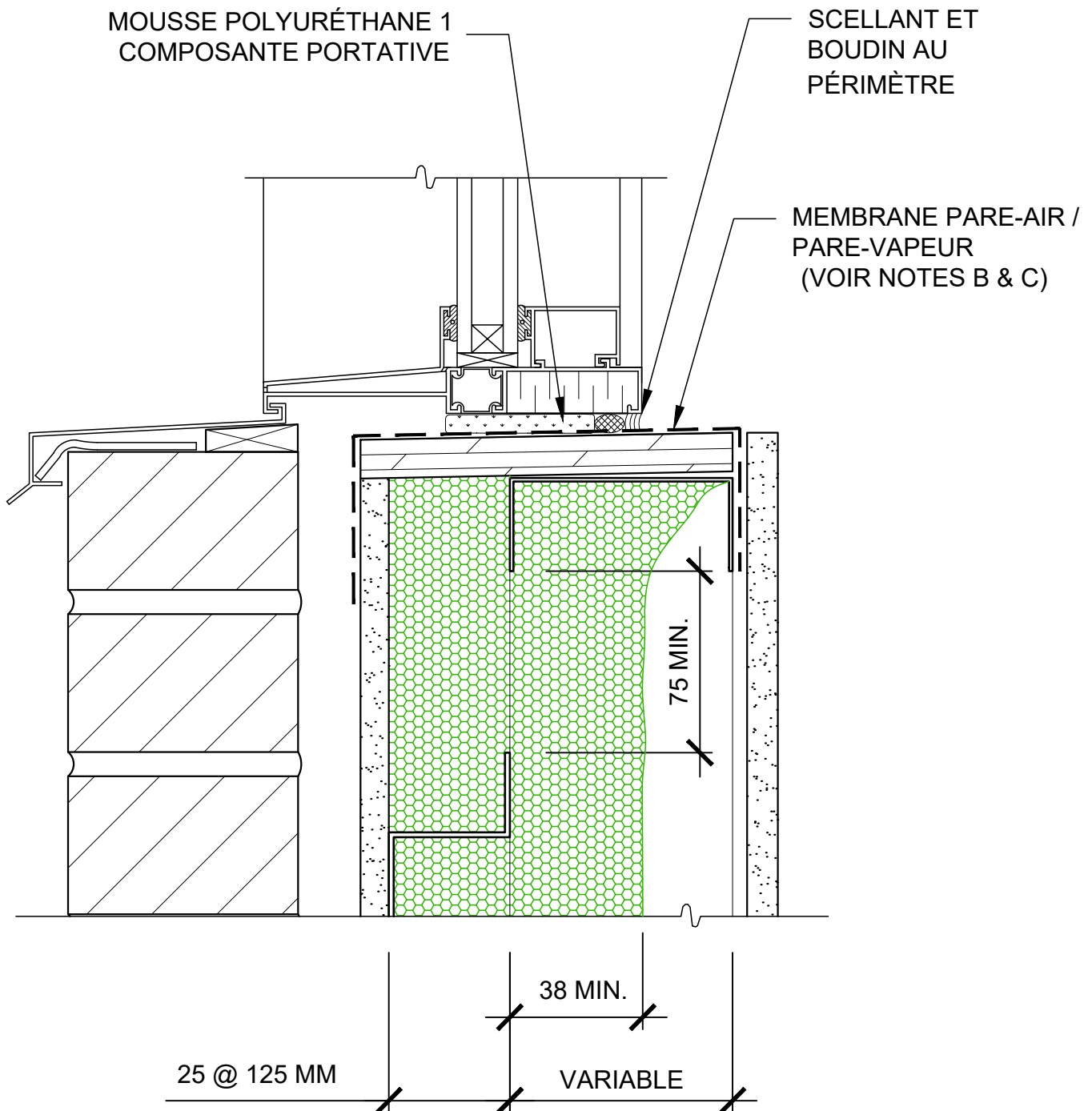

SEUIL DE FENÊTRE
REVÊTEMENT DE BRIQUE

Date: 03-05-2022

Échelle: 1:2.5

NOTE: POUR FIN DE SUPPORT AUX OUVERTURES, LES POTEAUX DE SUPPORTS DE FENÊTRES PEUVENT ÊTRE DOUBLÉS ET INJECTÉS AVEC AIRMÉTIC SOYA HFO.

OPTION

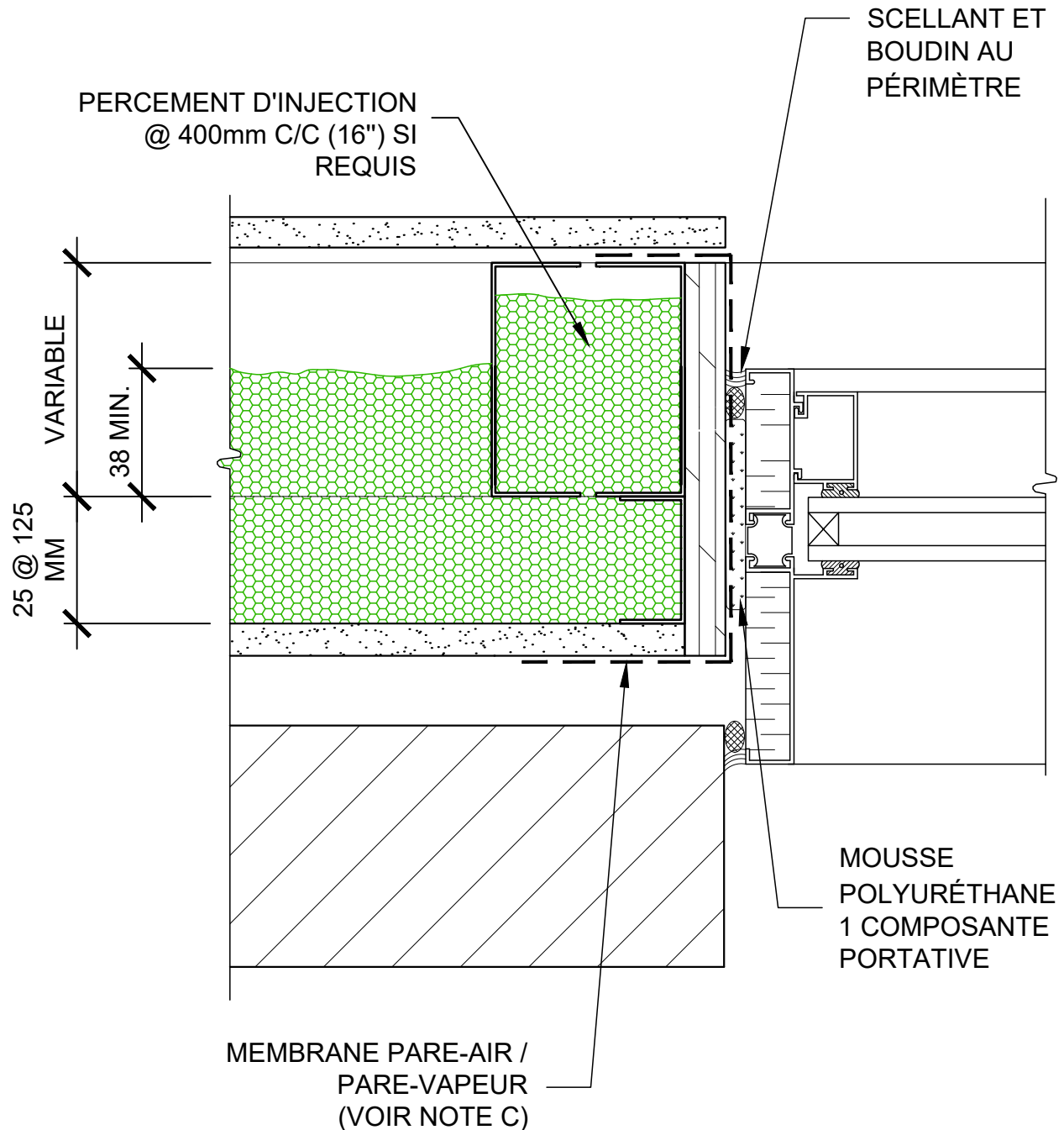

JAMBAGE DE FENÊTRE
REVÊTEMENT DE BRIQUE

Date: 03-05-2022

Échelle: 1:2.5

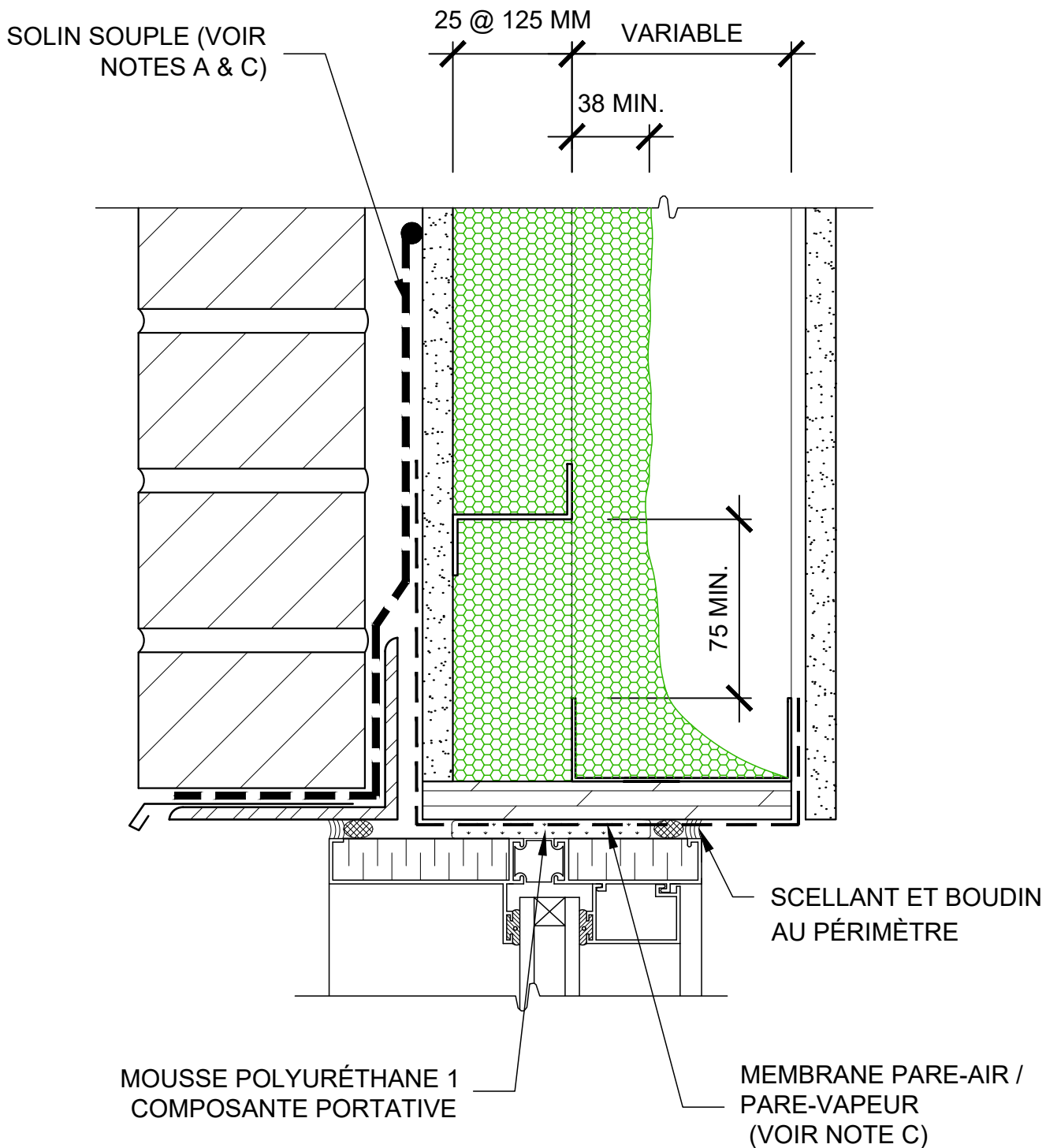

TÊTE DE FENÊTRE
REVÊTEMENT DE BRIQUE

Date: 03-05-2022

Échelle: 1:2.5

MOUSSE POLYURÉTHANE 1
COMPOSANTE PORTATIVE

SCELLANT ET
BOUDIN AU
PÉRIMÈTRE

MEMBRANE PARE-AIR /
PARE-VAPEUR
(VOIR NOTES B & C)

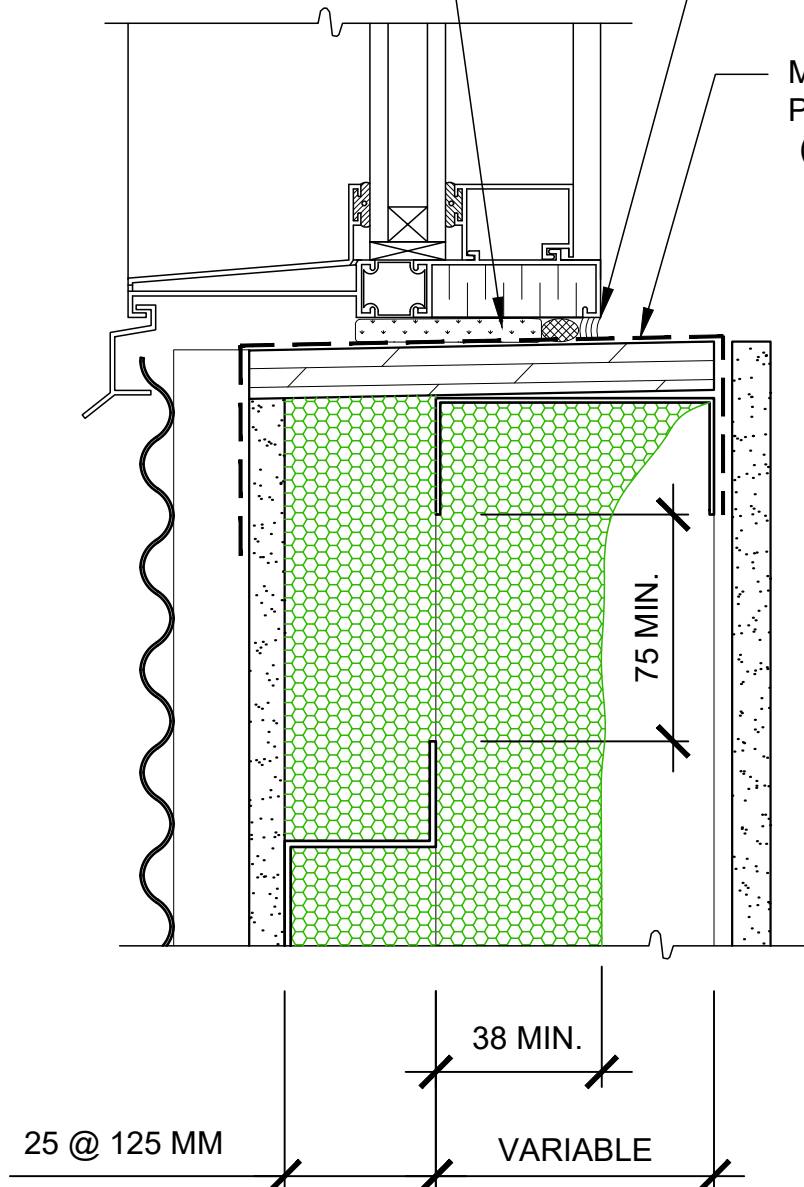

SEUIL DE FENÊTRE
REVÊTEMENT LÉGER

Date: 03-05-2022

Échelle: 1:2.5

NOTE: POUR FIN DE SUPPORT AUX OUVERTURES, LES POTEAUX DE SUPPORTS DE FENÊTRES PEUVENT ÊTRE DOUBLÉS ET INJECTÉS AVEC AIRMÉTIC SOYA HFO.

OPTION

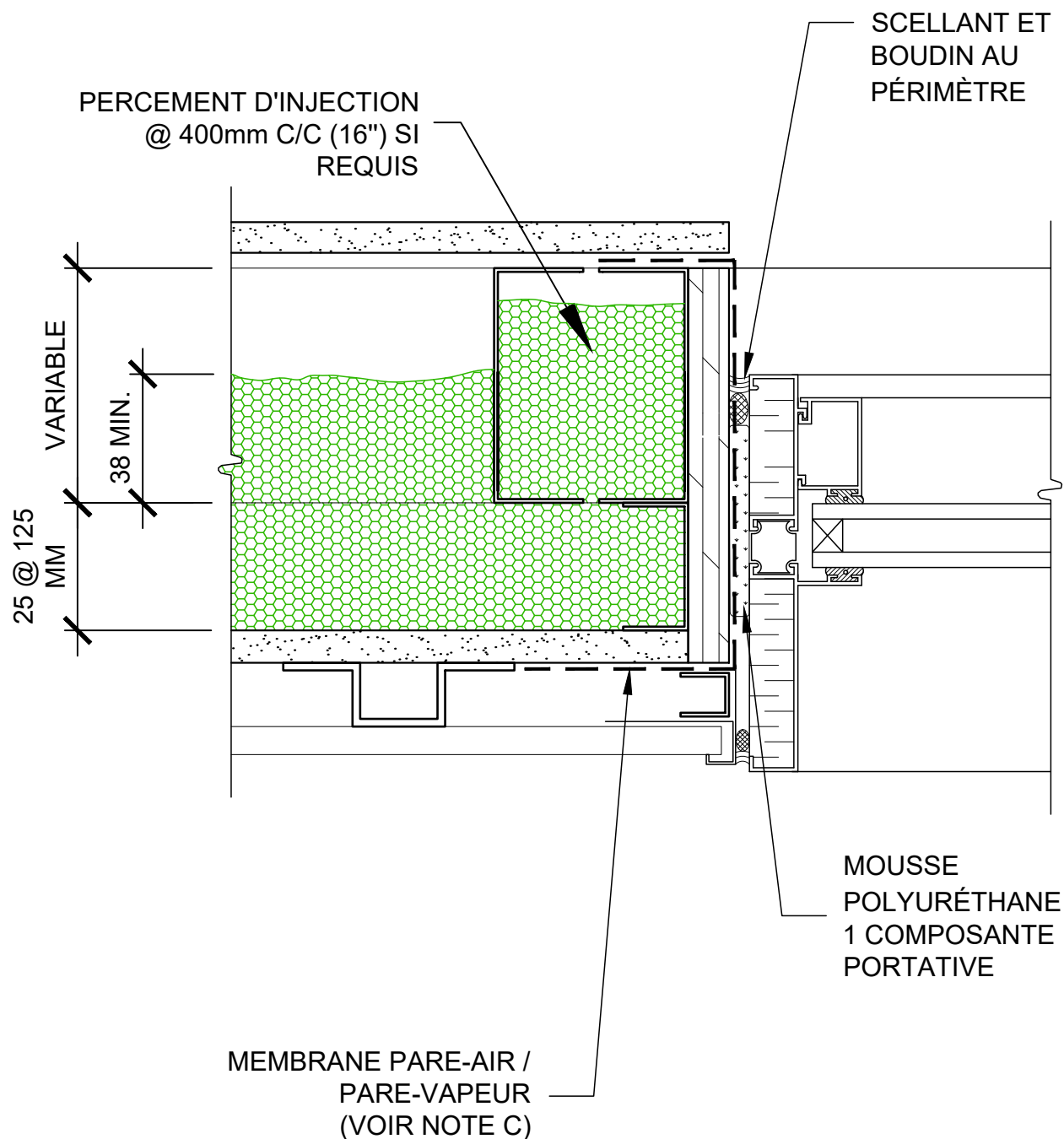

JAMBAGE DE FENÊTRE
REVÊTEMENT LÉGER

Date: 03-05-2022

Échelle: 1:2.5

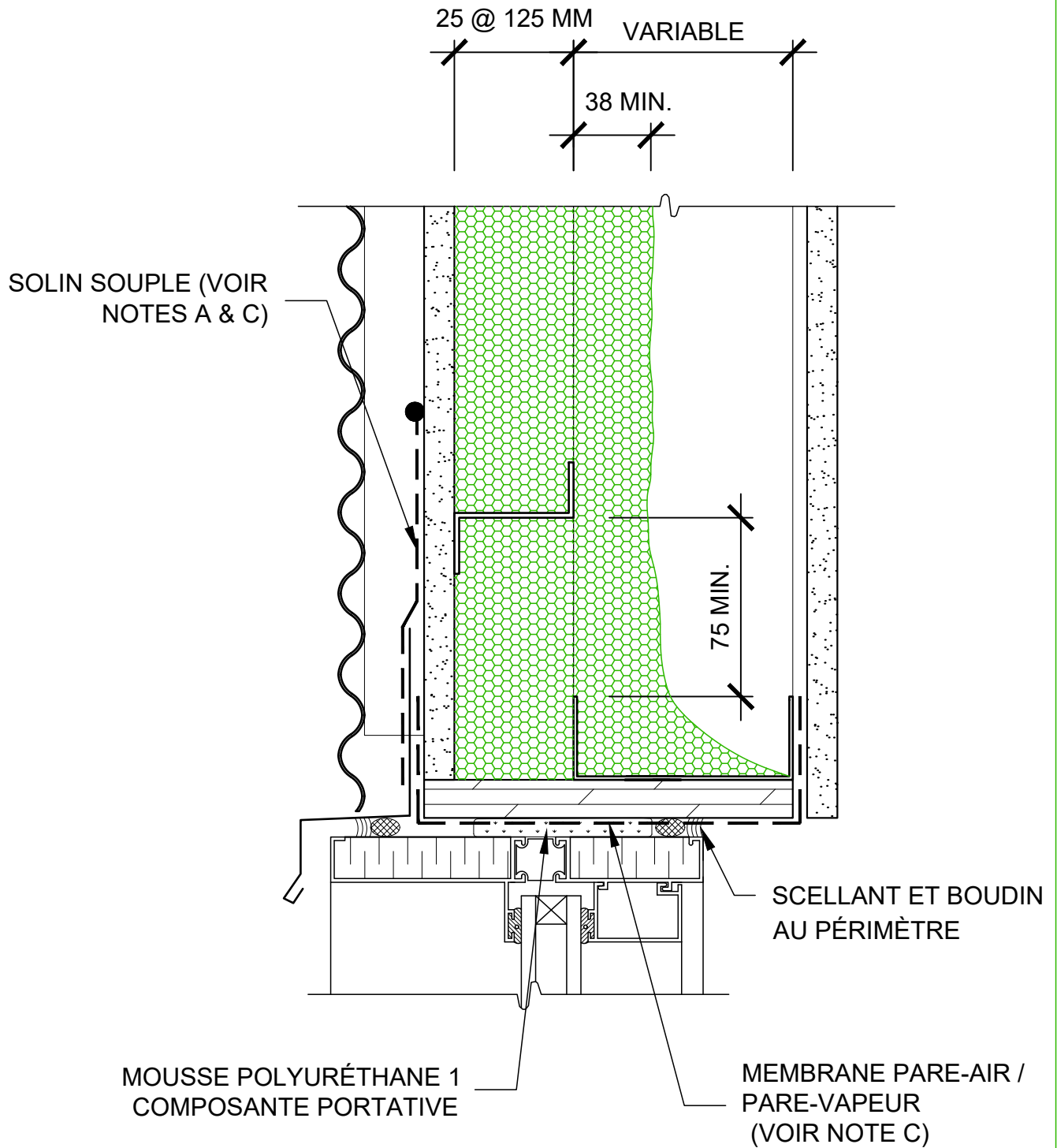

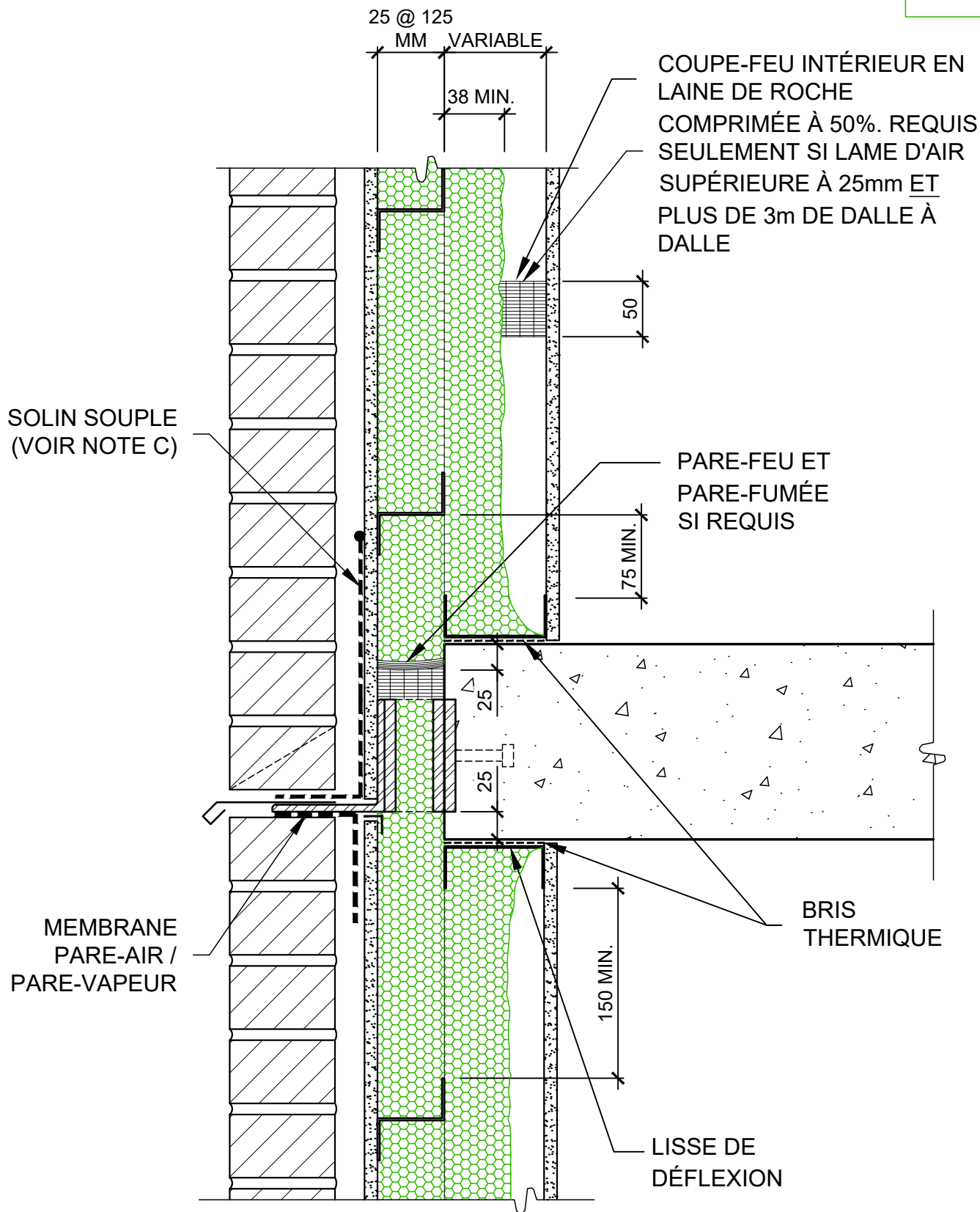

JONCTION PLANCHER
REVÊTEMENT DE BRIQUE

Date: 03-05-2022

Échelle: 1:5

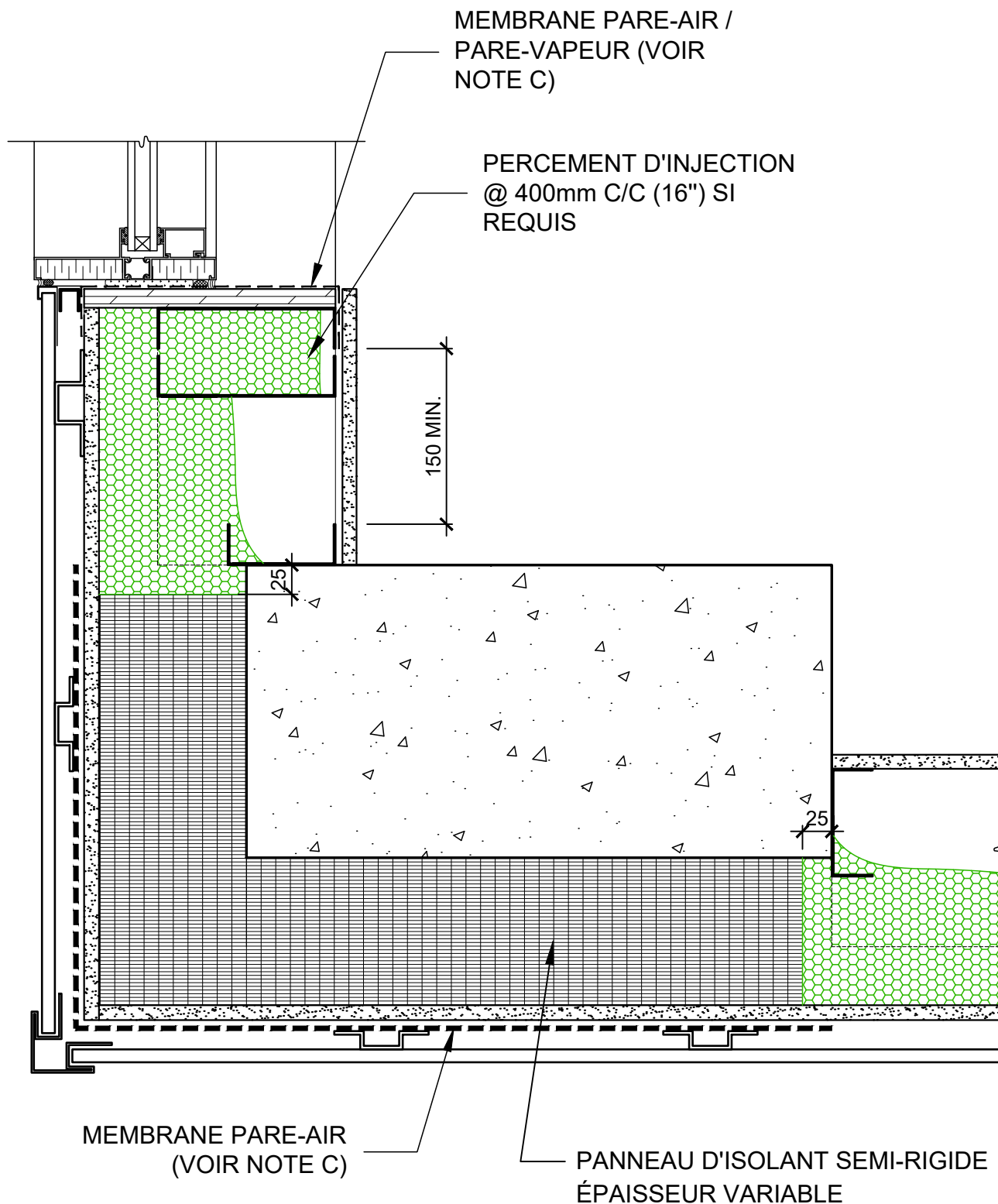

JONCTION COLONNE ET MUR - COIN DE BÂTIMENT
REVÊTEMENT LÉGER

Date: 03-05-2022

Échelle: 1:5

28 août 2019

A/S Maxime Duzyk
Demilec
870, Curé Boivin
Boisbriand, Québec
J7G 2A7

Projet : Coupe de mur avec barres en Z -- Demilec

Suite à votre demande et à nos discussions, vous trouverez ci-dessous les recommandations préliminaires concernant les épaisseurs requises des barres en Z @ 24" c/c pour des profondeurs variant de 1" @ 5".

Charges mortes considérées: 6 lb/pi²

- Panneau de mur en acier: 1.5 lb/pi²
- Panneau Glasroc 5/8": 2.5 lb/pi²
- Barre omega: 0.5 lb/pi²
- Barre Z: 0.5 lb/pi²
- Isolant: 1.0 lb/pi²

Épaisseur des barres en Z selon leur profondeur

- Profondeur de 1" @ 2" : Calibre 20 requis (0.0359")
- Profondeur de 2" @ 3 1/2" : Calibre 18 requis (0.0478")
- Profondeur de 3 1/2" @ 5" : Calibre 16 requis (0.0598")

Ces recommandations doivent être confirmées par l'ingénieur en structure des colombages métalliques du projet. Il doit tenir compte des charges de vent spécifiques pour chaque projet en plus des charges mortes. Les connexions des barres en Z aux colombages métalliques doivent également être spécifiées par ce dernier.

N'hésitez pas à communiquer avec nous pour des commentaires ou des questions.



Ronald Beaucage ing.
Beaucage Experts-Conseils

Assemblage D-Max - Résistance Thermique conformément à ASTM C1363 et ASHRAE 1365-RP

Zones Climatiques	Exigences de résistance thermique au Québec	
	R	RSI
6000 degrés-jours et moins	20.44	3.60
Plus de 6000 degrés-jours	22.99	4.05

Résistance Thermique - Assemblage D-Max - Airmétic Soya HFO									
Épaisseur de la barre Z		Espacement des barres Z		Épaisseur totale d'Airmétic Soya HFO		Résistance thermique effective		Valeur-U	
Pouces	mm	Pouces	mm	Pouces	mm	R	RSI	Imperial	Metric
3"	75	24" c/c	600 c/c	4.5	114.3	19.7	3.47	0.051	0.288
				5	127	20.7	3.65	0.048	0.274
				6	152.4	22.4	3.94	0.045	0.254
				6.5	165.1	23.2	4.08	0.043	0.245
				7.5	190.5	25	4.41	0.040	0.227
		16" c/c	400 c/c	4.94	125.4	17.8	3.14	0.056	0.318
				5.92	150.4	19.2	3.39	0.052	0.295
				6.75	171.5	20.4	3.59	0.049	0.279
				7	177.8	20.9	3.68	0.048	0.272
				8.5	215.9	23.3	4.11	0.043	0.243
2.25"	57	24" c/c	600 c/c	3.75	95.3	17.8	3.13	0.056	0.319
				5.5	139.7	20.7	3.65	0.048	0.274
				6	152.4	21.5	3.79	0.047	0.264
				7	177.8	23	4.05	0.043	0.247
				7.5	190.5	23.8	4.2	0.042	0.238
		16" c/c	400 c/c	3.75	95.3	15.6	2.75	0.064	0.364
				6	152.4	18.9	3.33	0.053	0.303
				7.25	184.2	20.7	3.64	0.048	0.262
				8	203.2	21.7	3.82	0.046	0.262
				9	228.6	24.3	4.28	0.041	0.234

* Avec revêtement extérieur générique (le revêtement extérieur a un impact négligeable sur les résultats)

* Colombages @ 16" c/c (la dimension des colombages a un impact négligeable sur les résultats)

* Valeurs pour la portion opaque seulement)

ASSEMBLAGE

- REVÊTEMENT LÉGER
- BARRES OMÉGA 25 MM
- MEMBRANE TYVEK PLEINE SURFACE OU MEMBRANE DE TRANSITION AUX JOINTS SEULEMENT
- REVÊTEMENT INTERMÉDIAIRE EXTÉRIEUR EN GYPSE 12.7MM
- BARRES Z CONTINUES 75MM CAL 18 @ 610 C/C FIXÉES AVEC VIS AUTOTARAUDEUSES no.14x1" AUX MONTANTS
- MONTANTS MÉTALLIQUES 90MM @ 406 C/C
- ISOLANT AIRMÉTIC SOYA HFO 125MM APPLIQUÉ ENTRE LES MONTANTS ET LES BARRES Z
- CAVITÉ D'AIR 40MM
- PANNEAU DE GYPSE INTÉRIEUR RÉG. 12.7MM

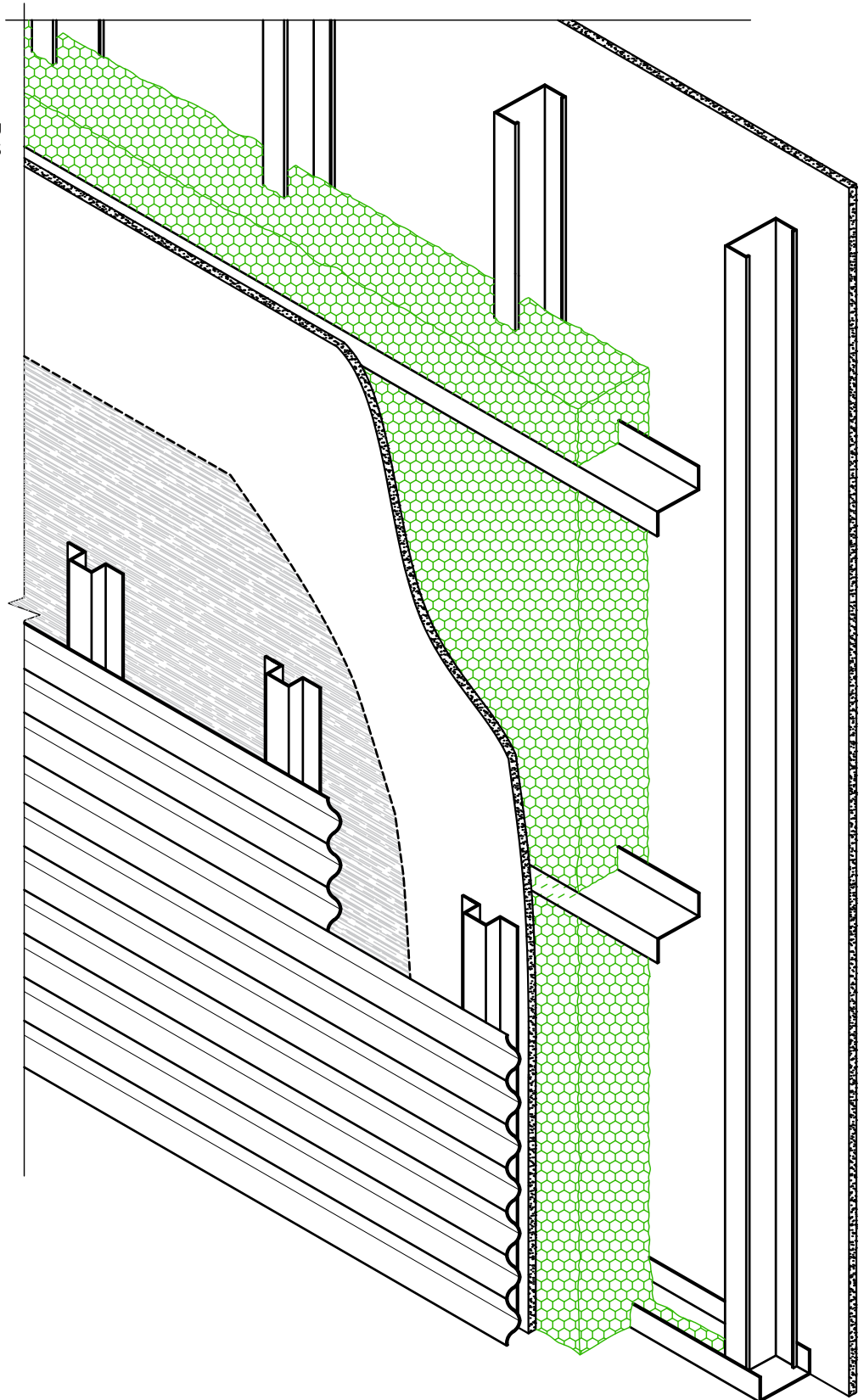

ISOMÉTRIE SCÉNARIO 3-3.5
REVÊTEMENT LÉGER

Date: 16-09-2021

Échelle: Variable

Assemblage de Mur D-Max – Étude acoustique

AOITC (Apparent Outside Inside Transmission Class) : représente un affaiblissement sonore exprimé en décibels (dB) en fonction d'une source ayant un spectre de référence précis. Cette valeur correspond à la différence entre le niveau de pression acoustique émis par une source sonore sur une façade d'un bâtiment et une pièce à l'intérieur de celui-ci. Puisqu'aucune source sonore est identique, le calcul s'appuie sur une source ayant un comportement fréquentiel virtuel établi dans la norme E1332 et fait en conformité à ASTM E966.

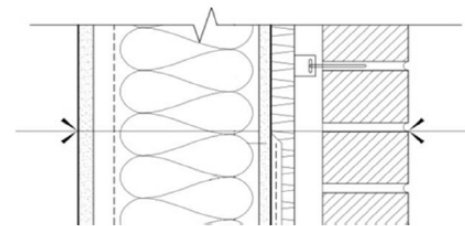
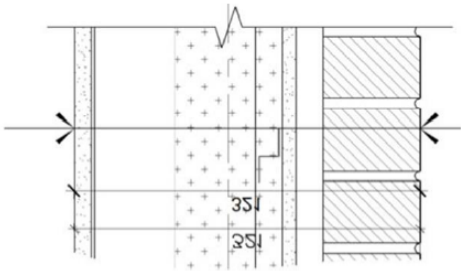
Test	Units	Cut	Assemblies	AOITC
#1 <i>Marc-Aurèle</i> (laine minérale)	721	M-1		42
#2 <i>Saphir</i> (Mur D-Max)	GF Bathroom	M-2		45

Avec une différence moyenne de 3 dB, la composition M-2 permet d'atténuer deux fois plus d'énergie sonore que la composition M-1.

FWFO7.EW25 - Exterior Wall Systems Certified for Canada

Exterior Wall Systems Certified for Canada

System No. EW25

October 1, 2021

Exterior Wall Systems Certified for Canada

Tested in accordance with a fifteen minute fire exposure as per: National Building Code of Canada 2015, clause 3.2.3.8(1)(b), and National Building Code of Canada 2010, clause 3.2.3.8(1)(b)

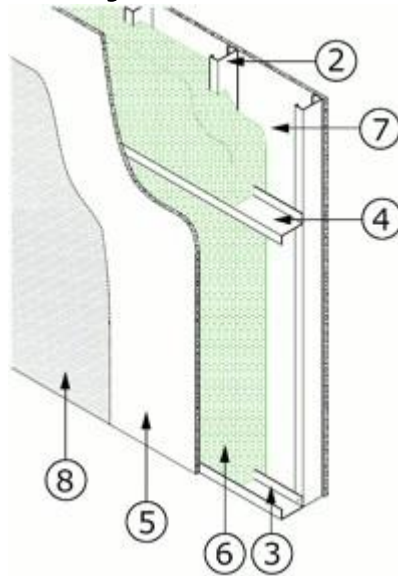

1. **Floor and Ceiling Tracks** — (not shown) 92 mm deep by 32 mm wide channel, 0.48 mm thick (26 gauge) galvanized steel, attached to masonry or concrete with fasteners spaced 610 mm OC.
2. **Steel Studs** — 92 mm deep by 38 mm wide channel, with 6 mm lip, 0.48 mm (26 gauge) thick galvanized steel, spaced 406 mm OC, fastened to the floor and ceiling tracks. Steel stud depth may vary depending on installed thickness of Item 6.
3. **C-channel** — 127 mm deep by 38 mm wide C-channel, 0.91 mm thick (20 gauge) galvanized steel, 3050 mm long, fastened to Item 2. C-channel located along the perimeter of the wall assembly. C-channel depth may be reduced depending on installed thickness of Item 6.
4. **Z-bar** — 127 mm deep by 38 mm wide Z-bar, 0.91 mm thick (20 gauge) galvanized steel, 3050 mm long, fastened to Item 2. Z-bar located at maximum 610 mm OC. Z-bar oriented horizontally. Z-bar depth may be reduced depending on installed thickness of Item 6. Z-bar must extend a minimum of 25 mm above the finished surface of Item 6.
5. **Gypsum Sheathing** — Minimum one layer of minimum 12.7 mm thick, UL Classified or ULC Listed, exterior gypsum sheathing, attached to steel studs and floor and ceiling track with Type S screws, 25 mm long, spaced 305 mm OC along edges of board in the field of the board.

CERTAINTED GYPSUM INC — GlasRoc

GEORGIA-PACIFIC GYPSUM L L C — Type DGG, DensGlass Gold Sheathing

UNITED STATES GYPSUM CO — USG SECUROCK® Sheathing

6. **Foamed Plastic** — Spray applied, foamed plastic insulation, maximum 32.7 kg/m³, to a maximum depth of 204 mm.

HUNTSMAN BUILDING SOLUTIONS — Airmetic Soya, Heatlok Soya, Polarfoam Soya, Airmetic Soya HFO, Heatlok Soya HFO, Polarfoam Soya HFO

7. **Gypsum Wallboard** — Minimum one layer of minimum 12.7 mm thick, UL Classified or ULC Listed, interior gypsum wallboard, attached to steel studs and floor and ceiling track with 3 mm diameter self-drilling screws, 25 mm long, spaced 305 mm OC along edges of board and in the field of the board.

8. **Weather Protection Membrane** — One layer of peel and stick vapor barrier, with 50 mm (maximum) overlap on all joints. Adhered with manufacturer's recommended primer at full coverage. Full surface or transitional.

Last Updated on 2021-10-01

The appearance of a company's name or product in this database does not in itself assure that products so identified have been manufactured under UL's Follow-Up Service. Only those products bearing the UL Mark should be considered to be Certified and covered under UL's Follow-Up Service. Always look for the Mark on the product.

UL permits the reproduction of the material contained in the Online Certification Directory subject to the following conditions: 1. The Guide Information, Assemblies, Constructions, Designs, Systems, and/or Certifications (files) must be presented in their entirety and in a non-misleading manner, without any manipulation of the data (or drawings). 2. The statement "Reprinted from the Online Certifications Directory with permission from UL" must appear adjacent to the extracted material. In addition, the reprinted material must include a copyright notice in the following format: "© 2021 UL LLC"

ENGINEERING JUDGMENT FIRESTOP DETAIL

PROJECT : D-MAX WALL
 CONTRACTOR : HUNTSMAN BUILDING SOLUTIONS
 F-RATING = 1-HR. OR 2-HR. (SEE NOTE NO. 2 BELOW)

CROSS-SECTIONAL VIEW

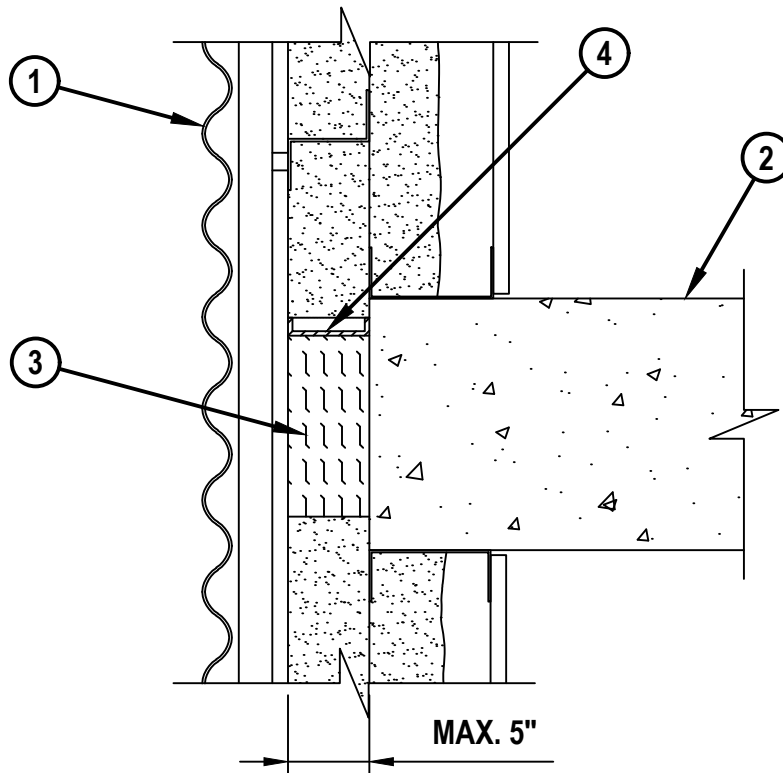

1. EXTERIOR DENSGLASS CURTAIN WALL ASSEMBLY WITH MAXIMUM 8" STEEL STUD FRAMING AND [OPTIONAL, NOT SHOWN] EIFS (NON FIRE-RATED).
2. CONCRETE FLOOR ASSEMBLY (MINIMUM 5" THICK) (1-HR. OR 2-HR. FIRE-RATING).
3. MINIMUM 4" THICKNESS MINERAL WOOL SAFING (MIN. 4 PCF DENSITY) COMPRESSED 33%. MINERAL WOOL MAY BE RECEESED BELOW TOP SURFACE OF FLOOR ASSEMBLY MAXIMUM 1".
4. MINIMUM 1/8" (WET) THICKNESS HILTI CFS-SP WB FIRESTOP JOINT SPRAY OR MINIMUM 2mm (WET) THICKNESS HILTI CFS-SP SIL FIRESTOP SILICONE JOINT SPRAY TO COMPLETELY COVER MINERAL WOOL, OVERLAPPING MINIMUM 1/2" ONTO ADJACENT ASSEMBLIES.

NOTES : 1. MAXIMUM WIDTH OF JOINT = 4".
 2. FIRE-RATING OF ASSEMBLY IS DEPENDENT UPON THE PERFORMANCE OF CURTAIN WALL ASSEMBLY UNDER FIRE CONDITIONS.
 3. THIS SYSTEM IS DESIGNED BASED UPON CANADIAN TEST STANDARD CAN/ULC-S115-2018 AND IN ACCORDANCE WITH ASTM E2307.

THIS ENGINEERING JUDGMENT REPRESENTS A FIRESTOP SYSTEM THAT WOULD BE EXPECTED TO PASS THE STATED RATINGS IF TESTED.
 (REFERENCE : INTERTEK SYSTEM NO. HI/BP 120-04 & HI/BP 120-03)

 Hilti Firestop Systems	HILTI, Inc. Plano, Texas USA (800) 879-8000	Sheet 1 of 1	Drawing No. 378451b
	Designed by <i>Nathan Jennings</i>	Scale 3/16" = 1"	
		Date Mar. 29, 2021	
Saving Lives through Innovation and Education			

ENGINEERING JUDGMENT FIRESTOP DETAIL

PROJECT : D-MAX WALL
CONTRACTOR : HUNTSMAN BUILDING SOLUTIONS
F-RATING = 1-HR. OR 2-HR. (SEE NOTE NO. 2 BELOW)

CROSS-SECTIONAL VIEW

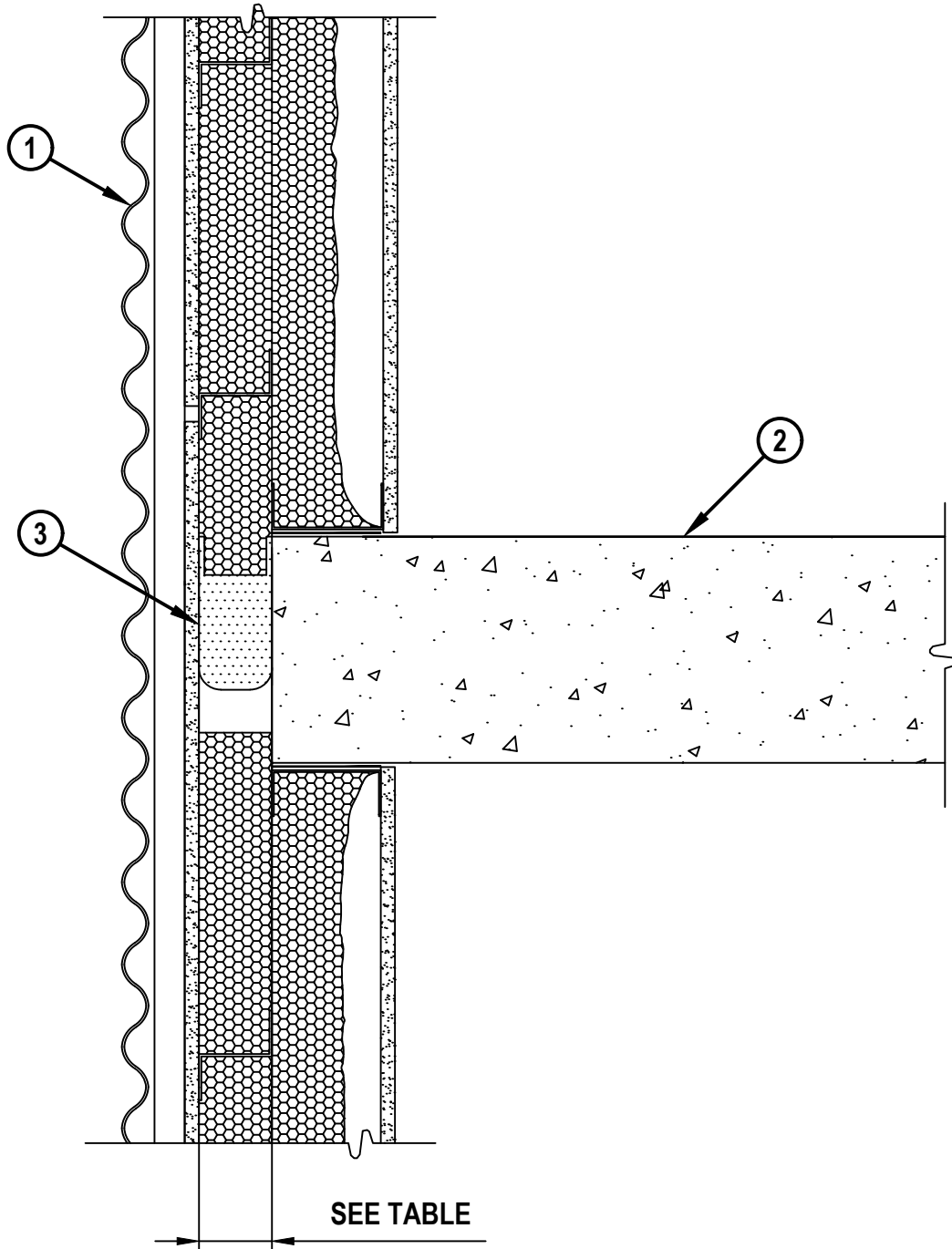

HILTI, Inc.
Plano, Texas USA (800) 879-8000
Designed by *Nathan Jennings*

Sheet	1 of 2
Scale	1/4" = 1"
Date	June 10, 2021

Drawing No.
524598a

ENGINEERING JUDGMENT FIRESTOP DETAIL

PROJECT : D-MAX WALL
 CONTRACTOR : HUNTSMAN BUILDING SOLUTIONS
 F-RATING = 1-HR. OR 2-HR. (SEE NOTE NO. 2 BELOW)

1. EXTERIOR DENSGLASS CURTAIN WALL ASSEMBLY WITH MAXIMUM 8" STEEL STUD FRAMING AND [OPTIONAL] EIFS (NON FIRE-RATED).
2. CONCRETE FLOOR ASSEMBLY (MINIMUM 5" THICK) (1-HR. OR 2-HR. FIRE-RATING).
3. COMPRESS THE APPROPRIATELY SIZED EDGE OF SLAB QUICKSEAL (CFS-EOS QS) PRODUCT (PER TABLE BELOW) INTO PERIMETER JOINT. REMOVE PAPER FROM ADHESIVE AND ADHERE FLAPS FIRMLY TO ADJACENT SUBSTRATES. SPLICES (BUTT JOINTS) IN THE LENGTH OF EDGE OF SLAB QUICKSEAL (CFS-EOS QS) ARE TO BE TIGHTLY COMPRESSED TOGETHER (MINIMUM 1/4" COMPRESSION).

PRODUCT	ALLOWABLE JOINT WIDTH	
	MINIMUM	MAXIMUM
CFS-EOS QS SMALL	1-1/2"	3"
CFS-EOS QS MEDIUM	2"	4"
CFS-EOS QS LARGE	3"	5"

NOTES : 1. MAXIMUM WIDTH OF JOINT = 4".
 2. FIRE-RATING OF ASSEMBLY IS DEPENDENT UPON THE PERFORMANCE OF CURTAIN WALL ASSEMBLY UNDER FIRE CONDITIONS.
 3. THIS SYSTEM IS DESIGNED BASED UPON CANADIAN TEST STANDARD CAN/ULC-S115-2018 AND IN ACCORDANCE WITH ASTM E2307.

THIS ENGINEERING JUDGMENT REPRESENTS A FIRESTOP SYSTEM THAT WOULD BE EXPECTED TO PASS THE STATED RATINGS IF TESTED.
 (REFERENCE : INTERTEK SYSTEM NO. HI/BP 120-04, HI/BP 120-03, HI/BPF 120-25 & HI/BPF 120-18)



Hilti Firestop Systems

HILTI, Inc.
 Plano, Texas USA (800) 879-8000

Designed by

Nathan Jennings

Sheet 2 of 2

Scale -

Date June 10, 2021

Drawing No.

524598a

Saving Lives through Innovation and Education

EDGE OF SLAB QUICKSEAL CFS-EOS QS

Product description

- The industry’s first preformed solution for edge of slab and curtain wall firestopping, the new CFS-EOS QuickSeal represents Hilti’s leading innovation that is redefining the future of firestop safety.

Applications for use

- Sealing building perimeter gaps between floor slabs and exterior curtain wall facades

Advantages

- Easy, dry, and clean installation — no mineral wool fiber, spray or equipment required.
- Fast inspection — preformed firestop solutions may not require destructive testing
- Zero waste — controlled material cost / easy to bid
- Superior temperature ranges compared to traditional sprays and sealants
- Low VOC to meet owners sustainability requirements — LEED V4 and Living Building Challenge

Installation instructions

- Use minimum 1” width metal roller for concrete floor and pre-cast concrete walls to ensure flap glue adhesion. See Hilti’s literature for third-party listings for complete application and installation for use.



Technical Data

Chemical basis	Polyurethane foam
Color	Silver/ Red
Recommended Application temperature	23° to 122°F (-5° to 50°C)
Storage and transportation temperature range	14° to 122°F (-10° to 50°C)
Temperature resistance range	-31° to 140°F (-35° to 60°C)
Movement	Yes
Mold and mildew performance	Class 1 (ASTM G21-96)
Tested in accordance with	ASTM E2307, CAN/ULC S115, ASTM D6904 (rain resistance)
LEEDv4.1 Compliant	CDPH Standard Method v1.2-2017
LEED VOC	2 g/L
Length	60 in (5ft)
Acoustics performance	52 (relates to specific construction) ASTM E90
Shelf Life	24 months at 23°F - 122°F
Joint Width	1.5" - 5" (compatible with Hilti Spray for joints outside the allowable range)

Specifications

- For the edge of slab conditions use pre-formed polyurethane foam based material for use as part of a perimeter fire barrier between fire resistance rated floors and exterior wall assemblies. Use tested systems HI/BPF 120-18 and 19, HI/BPF 120-20 and 21, HI/BPF 120-22 & 23, and HI/BPF 120-27 issued by Intertek Laboratories.

Order designation	Sales pack quantity	Item number
CFS-EOS QS Small (Joints 1.5" - 3")	28	2223950
CFS-EOS QS Medium (Joints 2" - 4")	21	2223951
CFS-EOS QS Large (Joints 3" - 5")	15	2223952



Instructions above are general guidelines – Always refer to 3rd party published listings or Hilti firestop system guide for complete installation information

Optional Water Tightness:

- CFS-EOS WS Edge of Slab WaterStop (for QuickSeal only)



Order designation	Item number
CFS-EOS WS	2242385

Specified Divisions

- DIV. 7: 07 84 43 Joint Firestopping
- DIV. 7: 07 84 53 Building Perimeter Firetopping
- DIV. 8: 08 44 00 Curtain Wall and Glazed Assemblies



Fire Protection Products



ENGINEERING JUDGMENT FOR:
9/3/2020
Marc Simard
3M Canada Company

Project: Mur D-Max	Contractor: TBD
Firestopping Category: Joints / Perimeter	Hourly Rating Requested / Type: 1 and 2 Hour / F Obtainable Rating: *see below
Joint Type: Perimeter	Maximum Joint Width: 4 Inch
Curtain Wall: Exterior Grade Fiberglass Sheathed Gypsum Board	Slab Assembly: Concrete Floor
Type of Movement: Dynamic	

<p>Special Conditions: Field conditions like Intertek Design 3MU/JS 120-22 with deviation of spray foam in lieu of the optional mineral wool batt curtain wall insulation. Steel studs terminate at top and bottom of concrete floor instead of passing through joint, and are tied to exterior wall with horizontal Z-shaped framing. Firestop may be recessed up 1 in. below top surface of concrete floor.</p>
<p>Application Details: To firestop this application, install in accordance with Intertek Design 3MU/JS 120-22 with the following modifications/clarifications:</p> <ol style="list-style-type: none"> 1. Install min 4 in. depth of min 4 pcf mineral wool compressed min 33% within the joint. Mineral wool may be recessed below top surface of floor assembly maximum 1 in. 2. Install one of the following over the mineral wool: <ul style="list-style-type: none"> • Install a 1/10 in. wet thickness of Watertight Spray or 1/8 in. wet thickness of FireDam Spray 200 over the mineral wool. <ul style="list-style-type: none"> o Watertight Spray or FireDam Spray 200 to overlap minimum ½ in. onto all surrounding substrates. • Install a minimum ¼ in. depth of sealant to completely cover the mineral wool. Sealant to be level with the top surface of the floor. • Install Fire and Water Barrier Tape to completely cover the mineral wool. <ul style="list-style-type: none"> o Tape to overlap minimum 1 in. onto all surrounding substrates. o Splices in the tape system to overlap minimum ½ in. 3. *The obtainable rating in this scenario is reduced to “Up to 1- or 2-hour F only or as long as the entire assembly remains fully intact in a fire scenario”.
<p>3M Fire Barrier Material: FireDam Spray 200, FB 1003SL Silicone Sealant, Fire and Water Barrier Tape, 3M Fire Barrier Watertight Spray</p>
<p>Based On: 3MU/JS 120-22</p>
<p>Additional Referenced System(s): (See Attached Drawing)</p>
<p>This Engineering Judgment (EJ) is based upon the sole and exclusive use of 3M brand Fire Protection Products as described within. Modification of any of the parameters of this EJ, including, without limitation, the use of non-3M brand Fire Protection Products, shall render this EJ null and void. This perimeter fire barrier design is expected to achieve the hourly rating indicated above. This engineering judgment is based on performance results obtained in testing with independent laboratories which have been tested in accordance to ASTM E 2307 and / or internal 3M fire tests, and CAN/ULC-S115.</p>

Engineering Judgment Prepared By:



Paul Fannin
Senior Application Engineer

Reviewed By:



610333
cc: Bethany Turowec
Email: bturowec@mmm.com

Technical Information, Product Selection and Use

The technical information, guidance and other statements contained in this document are based upon records, tests or experience that 3M believes are reliable, but the accuracy or completeness of such information is not guaranteed and may not be indicative of field conditions. Many factors beyond 3M's control and uniquely within user's knowledge and control can affect the use and performance of a 3M product in a particular application. As a result, customer is solely responsible for evaluating the 3M product and determining whether it is appropriate and suitable for customer's application. 3M product purchases are subject to the terms, conditions and limitations set forth in the applicable Technical Data Sheet

3M FIRE PROTECT

3M ENGINEERING JUDGEMENT NO. 610333
 MODIFIED SYSTEM NO. 3MU/JS 120-22
 REQUESTED F RATING - 1 & 2 HR
 OBTAINABLE RATING: *SEE BELOW

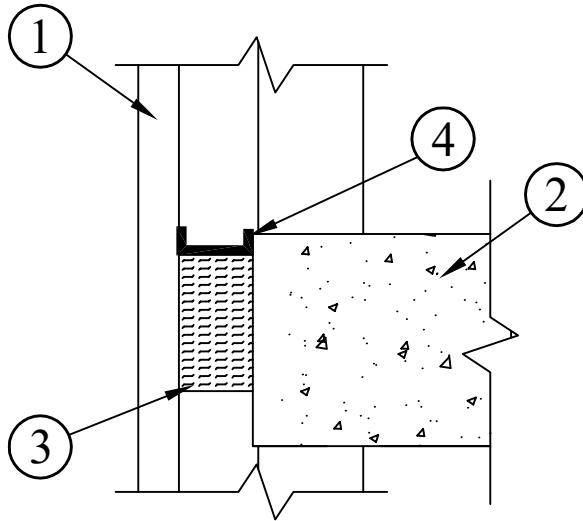

- 1. EXTERIOR GRADE FIBERGLASS SHEATHED GYPSUM BOARD..
- 2. CONCRETE FLOOR.
- 3. 4 PCF MINERAL WOOL.
- 4. FIRESTOP SEALANT/SPRAY AS OUTLINED IN APPROPRIATE VERSION OF CORRESPONDING EJ. (SPRAY DEPICTED)

*THE OBTAINABLE RATING IN THIS SCENARIO IS REDUCED TO "UP TO 1- OR 2-HOUR F ONLY OR AS LONG AS THE ENTIRE ASSEMBLY REMAINS FULLY INTACT IN A FIRE SCENARIO".

SEE APPLICATION DETAIL NOTES ON APPROPRIATE VERSION OF CORRESPONDING EJ.

CONFIGURATION OR ORIENTATION OF PENETRANT(S)/OPENING(S) MAY NOT MATCH SITE CONDITION(S).

CONSULT CURRENT INDEPENDENT TESTING LABORATORIES (UL/INTERTEK) FOR SYSTEMS OR DESIGN DETAILS

PROJECT:
MUR D-MAX

SIGNATURE:
Bruce Fitzwater

REV:	DATE:	DESCRIPTION	DRWN BY:
0	09-03-20	ORIGINAL ISSUE	BLF

THIS ELEMENTARY FIRESTOP DRAWING IS TO BE USED ALONG WITH THE CORRESPONDING ENGINEERING JUDGMENT AND REFERENCED LISTED/TESTED SYSTEMS FROM INDEPENDENT TESTING LABORATORIES (UL/INTERTEK). DRAWING NOT TO SCALE.

DWG. LOCATION:
610333.DWG

DATE:
09-03-20

ALL STATEMENTS, TECHNICAL INFORMATION AND RECOMMENDATIONS CONTAINED HEREIN ARE BASED ON TEST: WE BELIEVE TO BE RELIABLE, HOWEVER, SINCE THE CONDITIO OF USE AND APPLICATION ARE BEYOND OUR CONTROL, 3M SHALL NOT BE LIABLE FOR ANY DAMAGE, DIRECT OR CONSEQUENTIAL, RESULTING FROM THE USE OF THIS MATERI/ OR DESIGN. 3M'S ONLY WARRANTY SHALL BE TO REPLACE AN/ OF OUR PRODUCTS PROVED TO BE DEFECTIVE.

3M Fire Protection Products

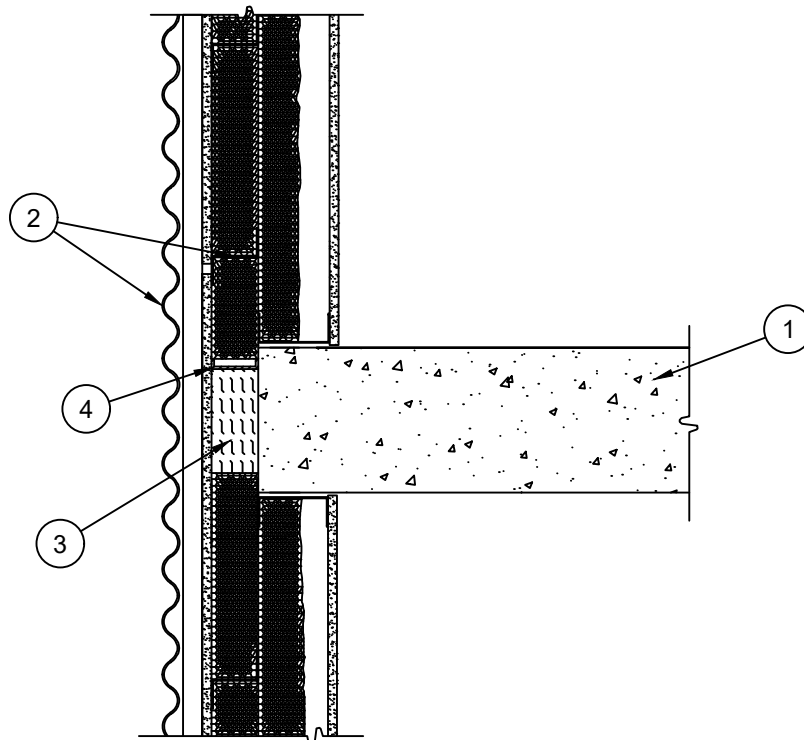

1. **Floor Assembly (2 Hr)** - Min 5" thick concrete floor assembly.
2. **Curtain Wall Assembly (Non Fire Rated)** - Exterior densglass curtain wall assembly with max 8" steel stud framing. Max width of joint is 4".
3. **Packing Material** - Min 4 pcf density mineral wool batt insulation compressed a min 33% and installed within joint to a min 4" depth, flush with top surface of floor. When sealant is used, recess to accommodate for the required depth of sealant.
4. **Spray** - SpecSeal® AS200, Fast Tack, or SFS Safing Spray applied to completely cover mineral wool to a min 1/8" wet thickness, overlapping onto surrounding substrates a min 1/2".
5. **Sealant (Optional)** - In lieu of spray, SpecSeal® SIL300SL Sealant applied within joint to a min 1/2" depth. Sealant to be flush with top surface of floor.

***Notes: 1** - Rating of the firestop system is dependent on the performance of the surrounding construction under fire exposure with a max possible F rating of 2 Hr.

THIS DESIGN REPRESENTS A FIRESTOP SYSTEM EXPECTED TO PASS THE STATED RATINGS IF TESTED

Project: Huntsman Building Solutions		Signature: 		System Reference: CW-D-1011	
Project Address:		Date: 3/31/2021		PAGE 1 OF 1	
Designed by: Joe Potts					
Contractor/Architect: Hunstman Building Services		Scale: N.T.S.		Based on testing to ASTM E2307 and CAN/ULC-S115 Standard Test Method of Fire Tests of Through-Penetration and Joint Firestops	



Specified Technologies Inc.

210 Evans Way • Somerville, NJ 08876 USA • Toll Free: 800-992-1130 • T: +1 908-526-8000
F: +1 908-231-8415 • E: techserv@stfirestop.com • www.stfirestop.com

All statements, technical information, and recommendations contained herein are based upon tests we believe to be accurate; however since the conditions of use and application are beyond our control, STI shall not be liable for any damage, direct or consequential, resulting from the use of this material or design. STI's sole warranty shall be to refund or replace materials found to be defective.